

Engineering and installation

Air source heat pumps

Ground source heat pumps

Water source heat pumps

Engineering and installation

Reprinting or duplication, even partially, is only allowed with our express permission.

STIEBEL ELTRON GmbH & Co. KG, D-37603 Holzminden

Legal note

Although we have tried to make this technical guide as accurate as possible, we are not liable for any inaccuracies in its content. Information concerning equipment levels and specifications is subject to modification. The equipment features described in this technical guide are non-binding regarding the specification of the final product. Due to our policy of continually improving our products, some features may have subsequently been changed or even removed. Please consult your local dealer for information about the very latest equipment features. The images in this technical guide are for reference only. The illustrations also contain installation components, accessories and special equipment that do not form part of the standard delivery.

Specification

Dimensions in the diagrams are in millimetres unless stated otherwise. Pressure figures may be stated in pascals (MPa, hPa, kPa) or in bars (bar, mbar). The details of threaded connections are given in accordance with ISO 228. Fuse types and sizes are stated in accordance with VDE. Output data applies to new appliances with clean heat exchangers.

HP principles

Table of contents

Heat pump principles	4	Air source heat pumps - outdoor installation	84
General function	4	Condensate drain	84
Air as heat source	6	Checklist, air source heat pumps, outdoor installation	85
Water as heat source	7	Air source heat pumps - indoor installation	86
Geothermal collector as heat source	8	Air routing	86
Geothermal probe as heat source	9	Condensate drain	88
Operating modes	10	Checklist, air source heat pumps, indoor installation	89
Dual mode operation	14	Geothermal heat pumps	90
Summary of formulae	16	Brine mixture	90
Regulations and standards - installation	18	Geothermal collector	92
Regulations and standards - design	19	Geothermal collector checklist	96
Heat load calculation	20	Geothermal probe	98
Heating surface temperature	21	Geothermal probe checklist	100
Design - Fixspeed, air source heat pumps	22	Water as heat source	102
Design - Fixspeed, ground source heat pumps	24	Heat source system	102
Design - Fixspeed, water source heat pumps	26	Well installation	103
Design - inverter, air source heat pump	27	Well pump	104
Design - inverter, ground source heat pumps	28	Intermediate heat exchanger	105
Electrical connection - Germany	30	Checklist, water source heat pumps	106
Heating water quality	32		
Heating water softening	34		
Buffer cylinder	40		
DHW heating	44		
DVGW W 511	44		
DIN 1988-200	45		
Systems for DHW heating	46		
Sizing	50		
DHW cylinder	50		
EN 15450 in apartment buildings/draw-off profile table	51		
Apartment building with centralised DHW cylinder	52		
Central DHW cylinder for residential buildings	54		
Instantaneous water cylinder for residential buildings	55		
Cylinder sizing for heat interface units	56		
Apartment building with centralised DHW heating	58		
Apartment building with heat interface unit	60		
Cooling	62		
Passive and active cooling	62		
Cooling load calculation	63		
Heat sinks for cooling operation	66		
Example designs	69		
Active cooling - air source heat pump	70		
Active cooling - ground source heat pump	71		
Passive cooling - ground source heat pump	72		
Area cooling	73		
Ceiling cooling	74		
Concrete core activation	75		
Fan convectors and cassette units	76		
Sound	78		
Sound power, sound power level	78		
Sound pressure level	79		
Law of Distance	80		
Noise propagation and structure-borne sound	81		
Sound engineering help	82		

Heat pump principles

General function

Heat pump principle

The heat transfer medium plays the most important role in the functioning of a heat pump. The heat transfer medium evaporates at low temperatures.

If, for example, outdoor air or water is routed via a heat exchanger in which the heat transfer medium is circulating, the heat transfer medium draws some of the heat from the heat source. In this process, the refrigerant changes from its liquid to its gaseous state. The heat source cools down.

In the next step, the refrigerant is passed through a compressor after which it is under a higher pressure. This increase in pressure also raises the temperature of the heat transfer medium.

Electrical energy for the compressor is required for this process.

The waste heat of the compressor motor is routed with the compressed heat transfer medium into the downstream condenser.

In the condenser, the heat transfer medium transfers the extracted heat to the water circulation system. The heat transfer medium now changes from a gaseous into a liquid state.

The pressure of the heat transfer medium is relieved with an expansion valve.

Heat pump coefficient of performance

The coefficient of performance ε_{WP} is equal to the quotient of heating output Q_{WP} and electrical power consumption P_{WP} in accordance with the following equation:

$$\varepsilon_{WP} = \frac{Q_{WP}}{P_{WP}}$$

ε_{WP}	Coefficient of performance
Q_{WP}	Heating output
P_{WP}	Power consumption

The COP indicates how much greater the benefit when offset against the cost.

This coefficient of performance is subject to the temperature of the heat source and that of the heat consumer. The higher the heat source temperature and the lower the heat consumer temperature, the higher the COP.

As an instantaneous value, the COP always relates to a specific operating state.

Schematic diagram: heat pump refrigerant circuit

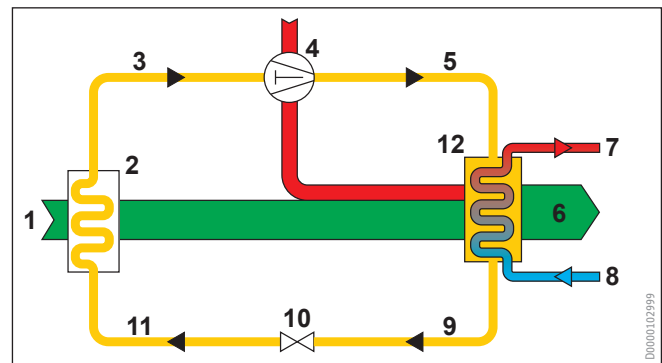

- 1 Environmental energy
- 2 Evaporator
- 3 Suction line, gaseous refrigerant, low pressure
- 4 Compressor
- 5 Pressure line, gaseous refrigerant, high pressure
- 6 Heating energy
- 7 Flow
- 8 Return
- 9 Liquid line, liquid refrigerant, high pressure
- 10 Expansion valve
- 11 Injection line, liquid refrigerant, low pressure
- 12 Condenser

Notes

Heat pump principles

Air as heat source

Air as heat source

Air heated by the sun is universally available. Air source heat pumps can draw sufficient energy for heating operation even at sub-zero outdoor air temperatures.

A heat pump can draw heat from the heat source air down to approx. $-20\text{ }^{\circ}\text{C}$.

As the heat source temperature falls, the COP is also reduced. A solution for this situation is to use a heat pump in conjunction with a second heat generator, which supports the heat pump during the short, particularly cold periods.

A significant benefit of air source heat pumps is easy installation. No soil work or well drilling is required.

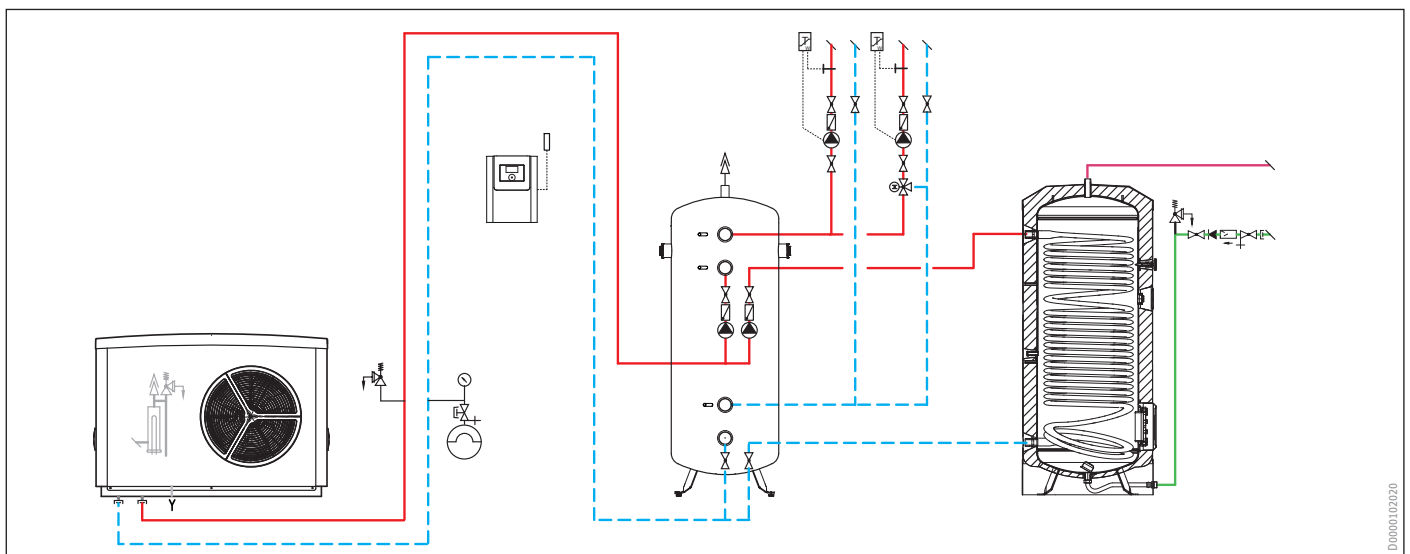

Heat pump principles

Water as heat source

Water as heat source

Groundwater is a good energy store for solar heat. Even on the coldest of winter days, well water holds a constant temperature of +7 °C to +12 °C.

The constant temperature level of the heat source enables the heat pump to achieve an almost constant coefficient of performance all the year round.

Groundwater of suitable quality is not universally available in sufficient quantities. A delivery well and a return well are required for heat utilisation.

In Germany, the relevant authority has to approve the use of groundwater.

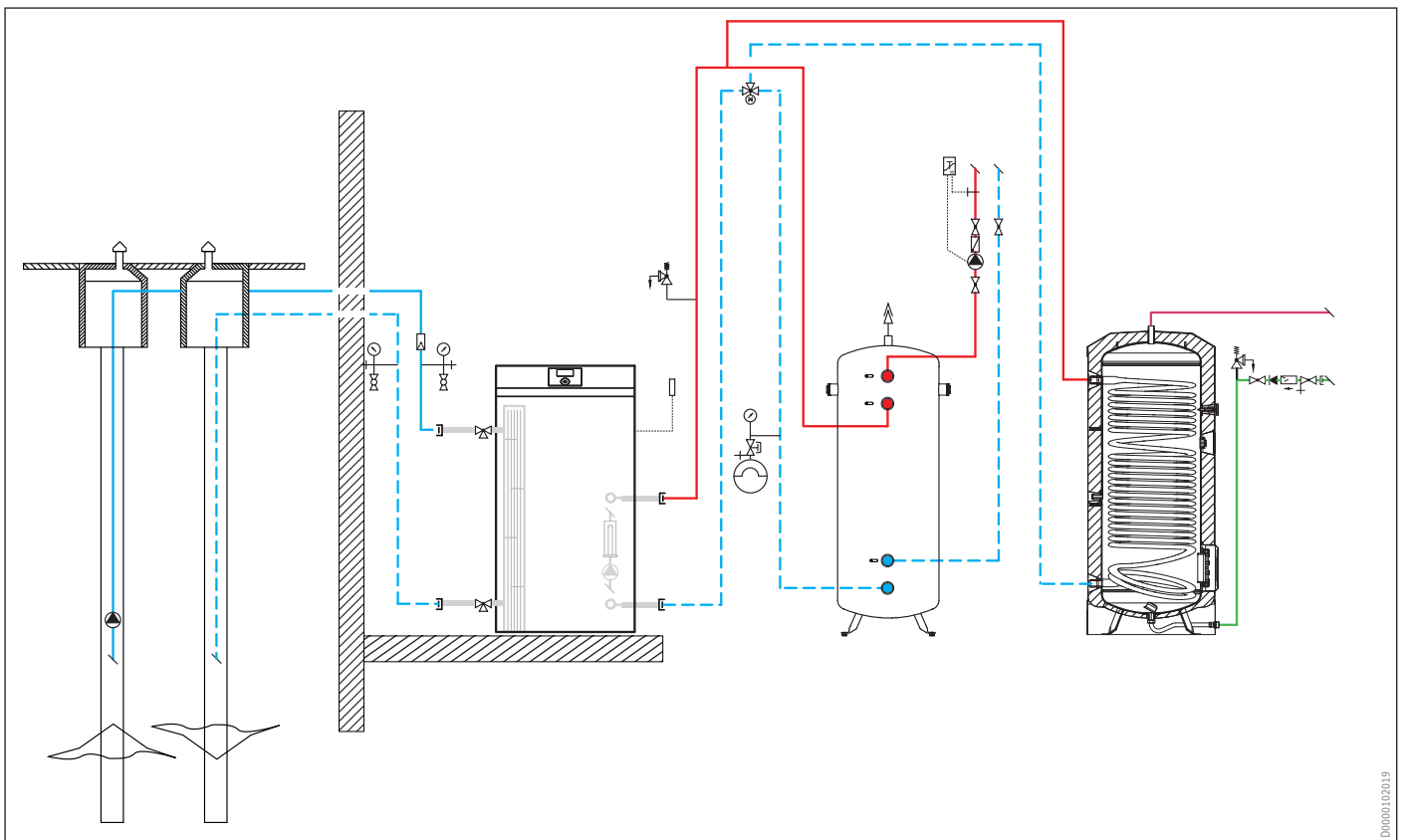

D0000102019

Heat pump principles

Geothermal collector as heat source

Ground as heat source with a geothermal collector

Below a depth of approx. 1.20 m to 1.50 m, the ground remains sufficiently warm in Central Europe to allow economical heat pump operation even on cold winter days.

For a geothermal collector, a sufficiently large land area is required for the pipework that absorbs the geothermal heat. This requires approx. two to three times as much ground surface area as the living space to be heated.

The extraction rate of a geothermal collector is between 10 and 15 W/m² in the case of a dry, sandy soil and up to 40 W/m² in the case of soil containing groundwater.

Geothermal collectors contain an environmentally friendly brine mixture that cannot freeze and which transports the yielded energy to the heat pump evaporator through the pipes.

If the land area is large enough, an inexhaustible energy reserve is available for a ground source heat pump.

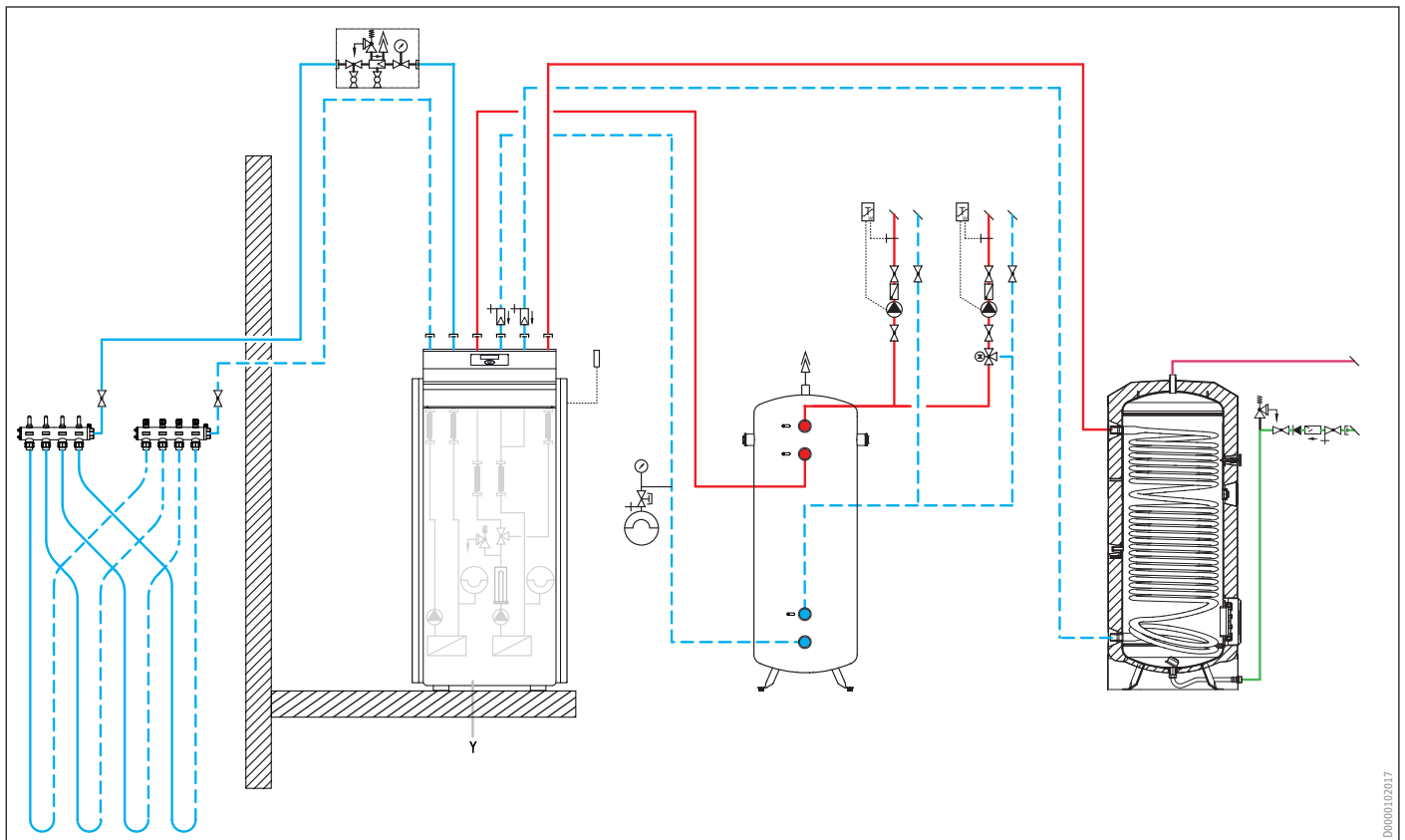

D0600102017

Heat pump principles

Geothermal probe as heat source

Ground as heat source with a geothermal probe system

Vertical geothermal probes require little ground surface area. Using specialist drilling equipment, geothermal probes can be sunk into the ground down to a depth of around 100 m.

Geothermal probes comprise a probe foot and vertical probe pipes made from plastic. A brine mixture that extracts heat from the ground circulates through the plastic pipework.

The extraction rate is dependent on the soil condition. The extraction rate is between approx. 30 and 100 W per metre of the geothermal probe. Subject to heat pump and ground conditions, several geothermal probes can be linked up to form a single heat source system.

In Germany, these systems must be registered and, if necessary, authorised by the local water board.

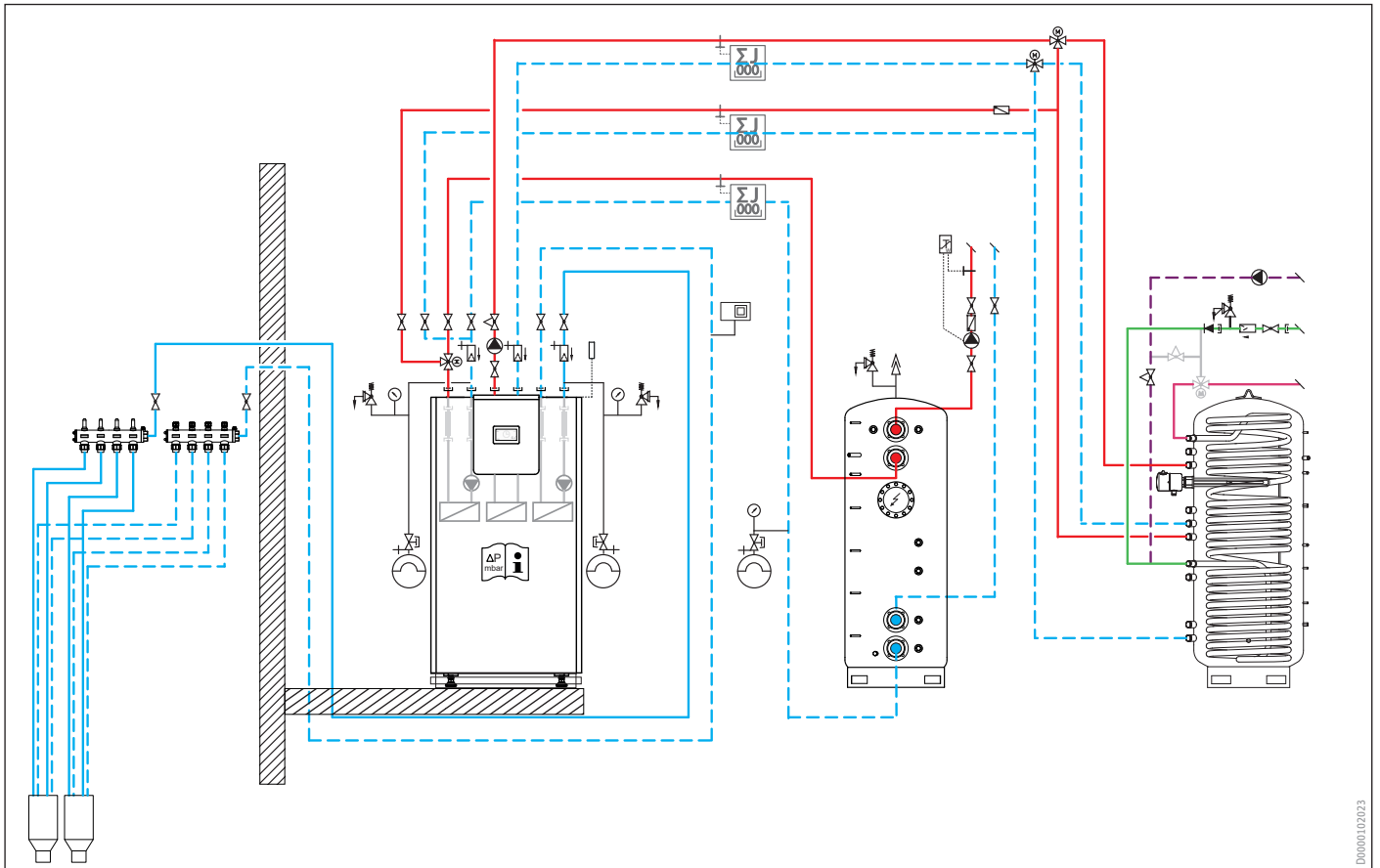

D0000102023

Heat pump principles

Operating modes

Mono mode operation

The heat pump is the sole heat generator. The heat pump covers the entire heat load for the building and DHW heating. This operating mode is suitable for all low temperature heating systems up to a maximum flow temperature of 60 °C. Design based on the calculated value must be carried out for the maximum flow

temperature at minimum heat source temperature. Mono mode is standard in heat pumps with brine or water as the energy source.

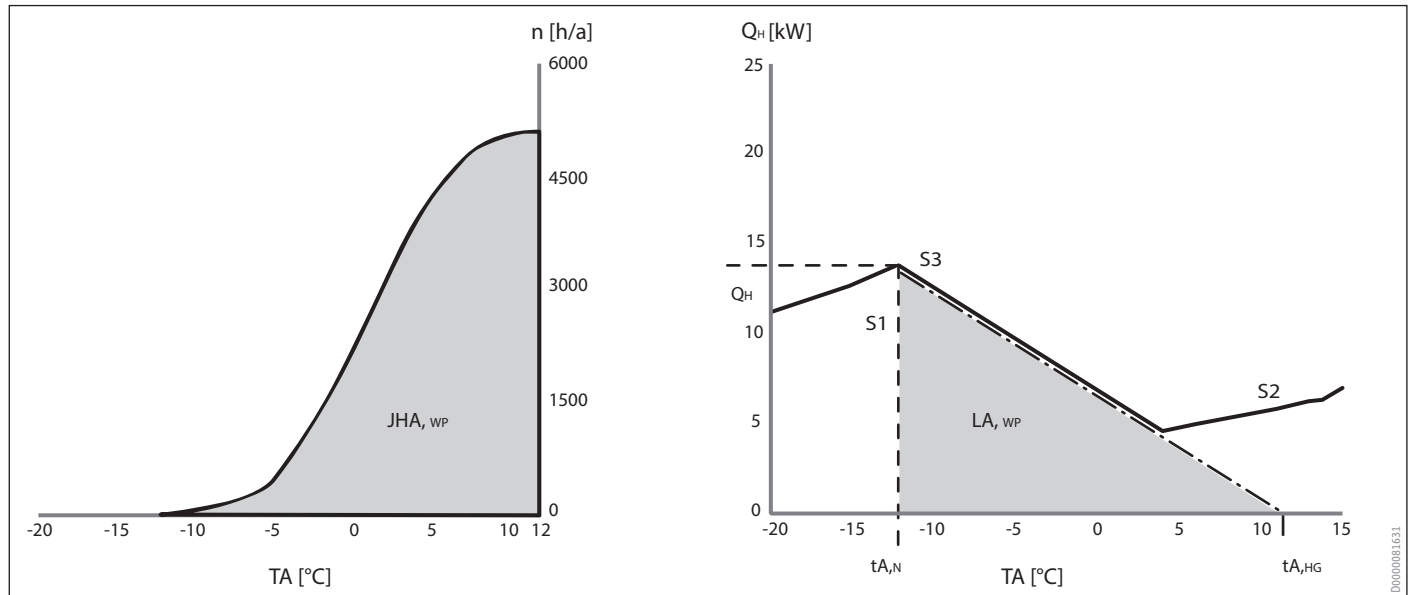

JHA_{WP}	Seasonal performance of the heat pump
JHA_{2WE}	Seasonal performance of the second heat generator
A	Shutdown point
B	Dual mode point
TA	Outside temperature
tA_B	Outside temperature in dual mode/shutdown point in °C
t1	Heat pump runtime
t2	Second heat generator runtime
n	Outside temperature cumulative frequency
S1	Design conditions
S2	Heat pump output

S3	Building heat load
A	Shutdown point
B	Dual mode point
LA_{WP}	Heat pump output ratio
LA_{2WE}	Output ratio of the second heat generator
tA_{HG}	Outside temperature at heating limit in °C
tA_N	Standard outside temperature in °C
tA_B	Outside temperature in dual mode/shutdown point in °C
TA	Outside temperature
Q_H	Building heat load at standard outside temperature in kW

Heat pump principles

Operating modes

Dual mode parallel / mono energetic mode

Peak outputs in winter are not covered by the heat pump alone, but with an electric emergency/auxiliary heater. Both heat generators then work in parallel. The share of the heat pump in the annual capacity is higher than with dual mode alternative operation.

This operating mode is suitable for underfloor heating systems and radiators up to the maximum heat pump flow temperature.

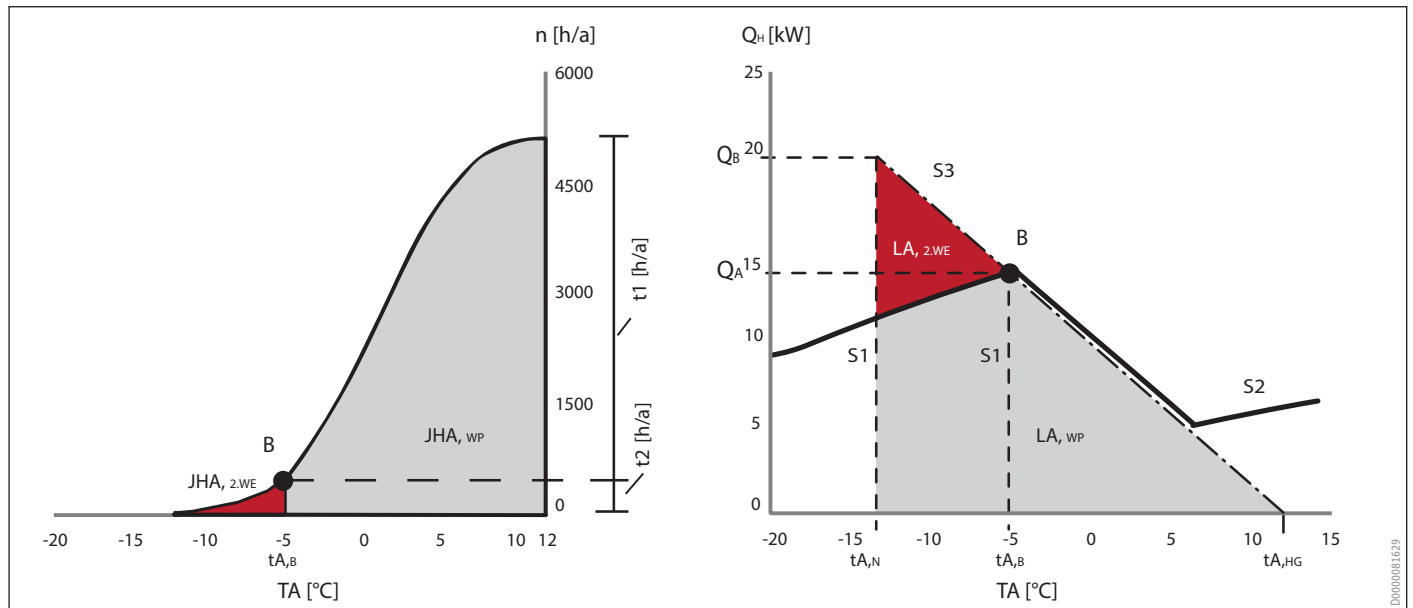

- JHA_{WP} Seasonal performance of the heat pump
- JHA_{2WE} Seasonal performance of the second heat generator
- A Shutdown point
- B Dual mode point
- TA Outside temperature
- tA_B Outside temperature in dual mode/shutdown point in °C
- t1 Heat pump runtime
- t2 Second heat generator runtime
- n Outside temperature cumulative frequency

- S1 Design conditions
- S2 Heat pump output
- S3 Building heat load
- A Shutdown point
- B Dual mode point
- LA_{WP} Heat pump output ratio
- LA_{2WE} Output ratio of the second heat generator
- tA_{HG} Outside temperature at heating limit in °C
- tA_N Standard outside temperature in °C
- tA_B Outside temperature in dual mode/shutdown point in °C
- TA Outside temperature
- Q_H Building heat load at standard outside temperature in kW

Coverage according to DIN 4701-10

Coverage α_{Ha} in dual mode parallel operation

Dual mode point T _E	°C	-10	-9	-8	-7	-6	-5	-4	-3	-2	-1	0	+1	+2	+3	+4	+5
Coverage		1.00	0.99	0.99	0.99	0.99	0.98	0.97	0.96	0.95	0.93	0.90	0.87	0.83	0.77	0.70	0.61

Heat pump principles

Operating modes

Dual mode alternative operation

The heat pump is solely responsible for heating until the outside temperature falls below a defined point that is set by the heating contractor. The defined outside temperature is known as the dual mode point. If the temperature falls below the dual mode point,

the heat pump switches off and the second heat generator takes over heating. This operating mode is possible for all heating systems above a flow temperature of 60 °C.

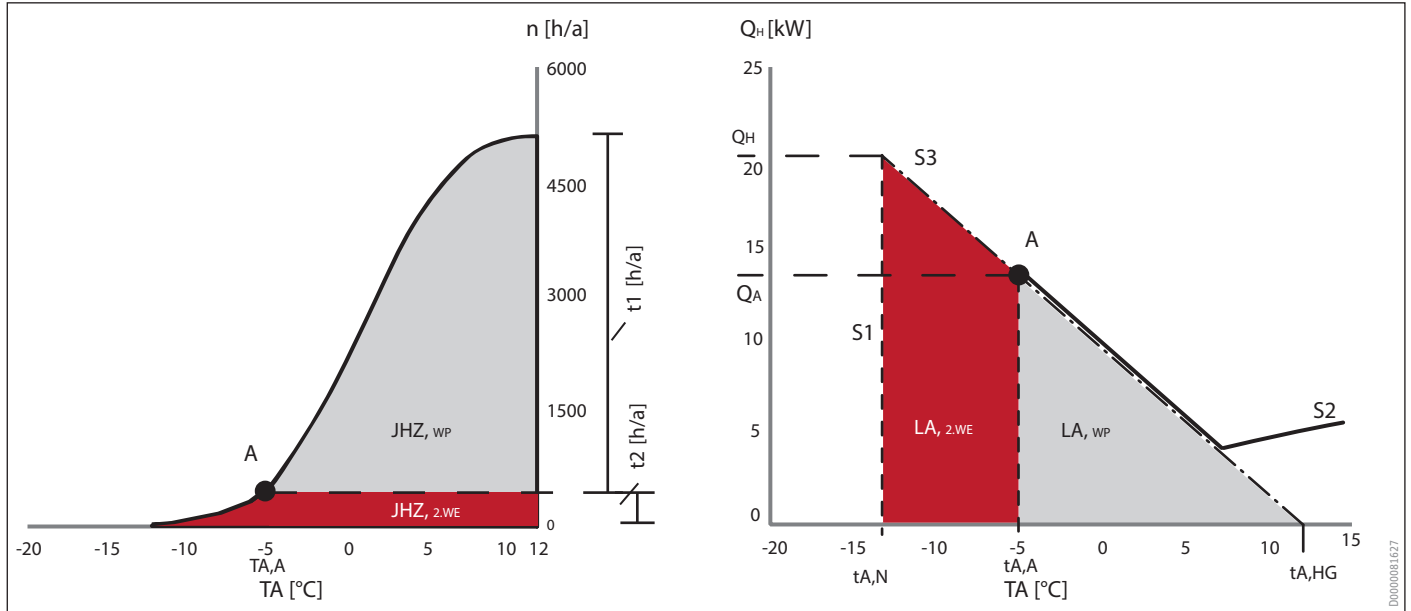

- JH_{WP} Seasonal performance of the heat pump
- JH_{2WE} Seasonal performance of the second heat generator
- A Shutdown point
- B Dual mode point
- T_A Outside temperature
- t_{A,B} Outside temperature in dual mode/shutdown point in °C
- t₁ Heat pump runtime
- t₂ Second heat generator runtime
- n Outside temperature cumulative frequency

- S1 Design conditions
- S2 Heat pump output
- S3 Building heat load
- A Shutdown point
- B Dual mode point
- LA_{WP} Heat pump output ratio
- LA_{2WE} Output ratio of the second heat generator
- t_{A,HG} Outside temperature at heating limit in °C
- t_{A,N} Standard outside temperature in °C
- t_{A,B} Outside temperature in dual mode/shutdown point in °C
- T_A Outside temperature
- Q_H Building heat load at standard outside temperature in kW

Coverage according to DIN 4701-10

Coverage α_{Ha} in dual mode alternative operation

Dual mode point T _U	°C	-10	-9	-8	-7	-6	-5	-4	-3	-2	-1	0	+1	+2	+3	+4	+5
Coverage		0.96	0.96	0.95	0.94	0.93	0.91	0.87	0.83	0.78	0.71	0.64	0.55	0.46	0.37	0.28	0.19

Heat pump principles

Operating modes

Dual mode partially parallel operation

The heat pump generates the required heat alone down to a specific outside temperature. The defined outside temperature is known as the dual mode point. If the temperature falls below this value, the second heat generator switches on. The heat pump

switches off when the flow temperature is no longer sufficient. The second heat generator supplies the entire heating output. This operating mode is suitable for all heating systems above a flow temperature of 60 °C.

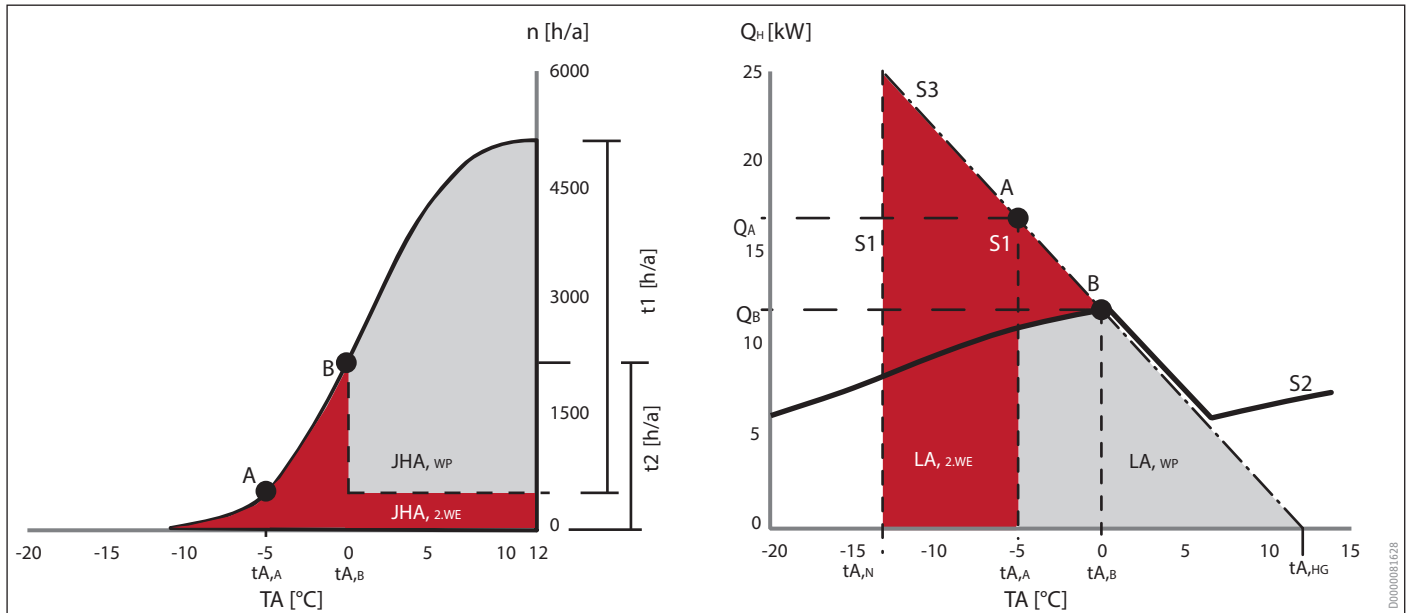

JHA_{WP}	Seasonal performance of the heat pump
JHA_{2WE}	Seasonal performance of the second heat generator
A	Shutdown point
B	Dual mode point
T_A	Outside temperature
$t_{A,B}$	Outside temperature in dual mode/shutdown point in °C
t1	Heat pump runtime
t2	Second heat generator runtime
n	Outside temperature cumulative frequency

S1	Design conditions
S2	Heat pump output
S3	Building heat load
A	Shutdown point
B	Dual mode point
LA_{WP}	Heat pump output ratio
LA_{2WE}	Output ratio of the second heat generator
$t_{A,HG}$	Outside temperature at heating limit in °C
$t_{A,N}$	Standard outside temperature in °C
$t_{A,B}$	Outside temperature in dual mode/shutdown point in °C
T_A	Outside temperature
Q_H	Building heat load at standard outside temperature in kW

Heat pump principles

Dual mode operation

Operation with an existing boiler

Most buildings can have a mono energetic supply using one heat pump.

In individual cases, it may be advantageous to temporarily select dual mode. If energy modernisation is planned in the medium term, a heat pump with a lower output can be installed when the existing boiler is replaced. The existing boiler will continue to operate until modernisation is carried out. After modernisation, the heat pump is large enough to heat the building and guarantee DHW heating.

Furthermore, from an economical viewpoint, it is worth reducing the coverage by the heat pump in favour of another heat generator. This can lead to economic efficiency benefits, for example where flow temperatures are high and this is reflected in local energy pricing.

Hydraulic connection

Dual mode systems with an existing heating system are incorporated hydraulically in such a way that the existing heating system can be removed without having to drain the entire system.

Once the existing heating system has been removed, the heat pump system will operate in mono energetic mode.

Electrical connection

Subject to the technical connection conditions of the relevant power supply utility responsible, the heat pump is operated via a separate electricity meter. It may be necessary here to ensure a means of control, e.g. via a ripple control receiver.

Depending on the power supply utility, one or two additional meter slots are required in the domestic distribution board. Technical points and registration must be arranged with the power supply utility.

In most cases, the existing junction box lacks the required space, for example, for the meter or fuses/MCBs. The existing junction box must be replaced or supplemented by an additional junction box.

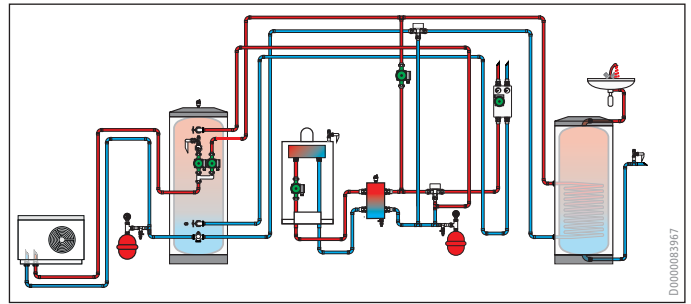

Notes

Heat pump principles

Summary of formulae

Amount of heat

$$Q = m * c * (t_2 - t_1)$$

Q	Amount of heat [Wh]
m	Amount of water [kg]
c	Specific heat [Wh/kgK] [1,163 Wh/kgK]
t ₁	Cold water temperature [°C]
t ₂	DHW temperature [°C]

Heating output

$$Q = A * k * \Delta\theta$$

Q	Heating output [W]
A	Area [m ²]
k	Heat transfer coefficient [W/m ² K]
Δθ	Temperature differential [K]

k value

$$k = \frac{1}{\frac{1}{\alpha_i} + \frac{d}{\lambda} + \frac{1}{\alpha_a}}$$

k	k value [W/m ² K]
α _i	Heat transfer coefficient, internal [W/m ² K]
α _a	Heat transfer coefficient, external [W/m ² K]
λ	Thermal conductivity [W/mK]

Connected load

$$P = \frac{m * c * (t_2 - t_1)}{T * \eta}$$

P	Connected load [W]
m	Amount of water [kg]
c	Specific heat [Wh/kgK]
t ₁	Cold water temperature [°C]
t ₂	DHW temperature [°C]
T	Heat-up time [h]
η	Efficiency

Ductwork curve

$$\frac{\Delta p_1}{\Delta p_2} = \left(\frac{V_1}{V_2} \right)^2$$

Δp ₁	Pressure differential [Pa]
Δp ₂	Pressure differential [Pa]
V ₁	Flow rate [m ³ /h]
V ₂	Flow rate [m ³ /h]

Heat-up time

$$T = \frac{m * c * (t_2 - t_1)}{P * \eta}$$

T	Heat-up time [h]
m	Amount of water [kg]
c	Specific heat [Wh/kgK]
t ₁	Cold water temperature [°C]
t ₂	DHW temperature [°C]
P	Connected load [W]
η	Efficiency

Pressure drop

$$\Delta p = L * R + Z$$

Δp	Pressure differential [Pa]
R	Pipe frictional resistance
L	Pipe length [m]
Z	Pressure drop of the individual resistances [Pa]

Individual resistances

$$Z = \sum Z * \frac{\zeta}{2} * v^2$$

Z	Drag coefficient The drag coefficient "Z" can be found in the tables using the sum "z" and the velocity in the pipework.
ζ	Density
v	Flow velocity [m/s]

Heat load – estimate

$$Q_N = \frac{B_a}{250}$$

Mixed water temperature

$$t_m = \frac{(m_1 * t_1) + (m_2 * t_2)}{(m_1 + m_2)}$$

t _m	Mixed water temperature [°C]
t ₁	Cold water temperature [°C]
t ₂	DHW temperature [°C]
m ₁	Amount of cold water [kg]
m ₂	Amount of DHW [kg]

Heat pump principles

Summary of formulae

Mixed water volume

$$m_m = \frac{m_2 * (t_2 - t_1)}{t_m - t_1}$$

m_m	Mixed water volume [kg]
m_1	Amount of cold water [kg]
m_2	Amount of DHW [kg]
t_m	Mixed water temperature [°C]
t_1	Cold water temperature [°C]
t_2	DHW temperature [°C]

Amount of DHW

$$m_2 = \frac{m_m * (t_m - t_1)}{t_2 - t_1}$$

m_m	Mixed water volume [kg]
m_1	Amount of cold water [kg]
m_2	Amount of DHW [kg]
t_m	Mixed water temperature [°C]
t_1	Cold water temperature [°C]
t_2	DHW temperature [°C]

Heat load – estimated according to oil consumption

$$Q_N = \frac{B_a * \eta * H_u}{b_{vH}}$$

Q_N	Heat load [kW]
B_a	Annual oil consumption [l]. Average consumption of the last 5 years, minus 75 l oil per person for DHW heating
η	Seasonal efficiency ($\eta = 0.7$)
H_u	Net calorific value of fuel oil [10 kWh/l]
b_{vH}	Hours of full utilisation (average value 1800 h/a)

Calculation of the sound pressure level from the sound power level

$$L_{pA} = L_{wA} + 10 \log_{10} \left[\frac{Q}{(4 * \pi * d^2)} \right]$$

L_{pA}	A - Weighted sound pressure level in dB(A)
L_{wA}	A - Weighted sound power level in dB(A)
Q	Correction factor
d	Distance in m

General conditions

The relevant country specific laws, standards, provisions and regulations must be observed when designing, installing and operating heat pump heating systems.

The contractor

The siting, installation, adjustment and commissioning of a heat pump system must be carried out by a qualified heating contractor.

Relevant regulations must be observed during installation and commissioning.

Electrical connection of the heat pump must be carried out by a qualified heating contractor approved by the relevant power supply utility (PSU). The installer also makes any necessary applications to the PSU.

Laws concerning the use of heat sources

The use of environmental heat is partially subject to legal regulations. Regulations ensure that other private and public interests are not compromised and that no harmful environmental influences are triggered by this measures. Observe the laws applicable to the relevant country.

Groundwater as heat source

In Germany, the use of groundwater as a heat source for a heat pump and the reintroduction of the cooled groundwater requires authorisation.

Ground as heat source

Water board notification or authorisation is generally required for the extraction of heat through underground pipes filled with a medium for heat transfer.

If, in Germany, a geothermal collector is in groundwater, authorisation may be required.

We recommend seeking clarification from the relevant water board during the system design phase.

Outdoor air as heat source

The use of outdoor air as a heat source is not subject to any legal regulations.

If the appliance is sited in an unfavourable position, the cooled air can cause a nuisance to neighbours.

Germany: German Immissions Act (BImSchG)

According to the German Immissions Act, heat pumps are not systems requiring authorisation.

Heat pump systems must be installed and operated to minimise avoidable nuisance.

Germany: TA-Lärm

In the case of noise emissions from the heat pump systems, observe the technical instructions for noise protection. For the living space, the sound pressure levels specified in the TA-Lärm table are defined as emission guidelines. The guideline emission values vary, depending on the surrounding buildings.

Germany: DIN standards

- » DIN V 18599 Energy efficiency of buildings
- » EN 12831 Heating systems in buildings – procedure to calculate the standard heat load
- » DIN 4109 Sound insulation in buildings
- » DIN 8901 Refrigerating systems and heat pumps – protection of the ground, groundwater and surface water – technical safety and environmental requirements and test

Heat pump principles

Regulations and standards - design

Germany: VDI guidelines

- » VDI 2067 Efficiency of technical building systems
- » VDI 2715 Noise reduction in hot water heating systems
- » VDI 4640-2 Thermal utilisation of the ground – ground source heat pump systems
- » VDI 4650 Calculation of heat pumps. Abridged procedure for calculating the annual expenditure of energy values of heat pump systems
- » VDI 2078 Cooling load calculation for air conditioned rooms
- » VDI 4645 Heating plants with heat pumps in single-family and multi-family houses

Germany: Regulations regarding the water side

- » EN 806 Specifications for installations inside buildings conveying water for human consumption
- » DIN 4708-1 Central heat-water-installations – Part 1: Terms and calculation basis
- » EN 378 Refrigeration systems and heat pumps – technical safety and environmental requirements
- » EN 14511-1 to 4 Air conditioners, liquid chilling packages and heat pumps with electrically driven compressors for space heating and cooling – Part 1: Terms and definitions; Part 2: Test conditions; Part 3: Test methods; Part 4: Requirements
- » EN 12828 Heating systems in buildings – Engineering hot water heating systems
- » TRD 721 Safety equipment to prevent excess pressure; safety valves for steam boilers in category II
- » DVGW Code of Practice W 101 Guidelines for protected potable water areas, Part 1: Protected groundwater areas
- » DVGW Code of Practice W 501 Potable water heating and routing systems – Technical measures for the reduction of the growth of legionella bacteria – Engineering, installing, operating and modernising potable water installations

Germany: Power regulations

- » VDE 0100 Regulations for the installation of HV systems up to 1000 V
- » VDE 0105 Regulations for the operation of HV systems
- » VDE 0700 Household and similar electrical appliances – Safety

Germany: Accident prevention instructions by the governing body of the trade associations

- » BGV D4 Accident prevention instructions; refrigerating equipment, heat pumps and cooling facilities

Additional standards and regulations for dual mode heat pump systems

Observe the following acts, standards, regulations and orders during the installation of an additional combustion system for solid, liquid or gaseous fuels:

Germany: Combustion Order

- » FeuVO Part II, § 4, Para. 2, Para. 4
- » EN 267 Oil combustion system – technical rules – oil combustion installation (TRÖ) – test

Germany: Safety principles

- » DIN 4787 Atomising oil burners, terminology, technical safety requirements, testing, identification
- » EN 12285-1 Workshop fabricated steel tanks – Part 1: Horizontal cylindrical single skin and double skin tanks for the underground storage of flammable and non-flammable water polluting liquids other than for heating and cooling of buildings
- » EN 12285-2 Workshop fabricated steel tanks – Part 2: Horizontal cylindrical single skin and double skin tanks for the above ground storage of flammable and non-flammable water polluting liquids
- » DIN 6618-1 Vertical single wall steel tanks for the above ground storage of flammable and non-flammable water polluting liquids
- » DIN 6619-1 Vertical single wall steel tanks for the underground storage of flammable and non-flammable water polluting liquids
- » DIN 6620-1 Steel cylinder banks (tanks) for the above ground storage of flammable liquids, safety category A III
- » DIN 6625-1 Locally-manufactured steel tanks for the above ground storage of flammable water polluting liquids in safety category A III and non-flammable water polluting liquids
- » DIN 18160-1 Chimneys
- » DIN 18381 German construction contract procedures (VOB) – Part C: General technical contract conditions for construction services (ATV) – gas, water and drainage pipework inside buildings

Germany: DVGW guidelines (DVGW Codes of Practice)

- » TRF 1996 Technical rules for LPG
- » G 430 Guidelines for the erection and operation of low pressure gas containers
- » G 600 Technical rules for gas installations
- » G 626 Technical rules for the mechanical routing of flue gases for open flue combustion equipment in flue and central ventilation systems
- » G 666 Guidelines for cooperation between the gas supply utilities and the contract installation companies

Heat pump principles

Heat load calculation

Standard building heat load

The standard heat load of a room or building determines the heating output that must be supplied to the room or building at standard outside temperature (design temperature) to achieve the standard inside temperatures or agreed room temperatures.

The standard heat load is a property of the room or building. The standard heat load is the basis for the design of the heat generator, the heat interface systems and the evaluation of the energy consumption.

Heat interface systems can comprise radiator or underfloor heating systems or hybrids of both.

The standard heat load comprises the heat flux through routing of heat via encompassing surfaces (transmission) and the heat flux for heating incoming outdoor air (ventilation heat load).

The standard heat load is calculated in Germany according to EN 12831.

The result of the calculation is key for sizing the heat pump system.

Oversizing or undersizing a heat pump system is uneconomical and technically disadvantageous for the system.

We always recommend precise calculation of the standard heat load.

Known fuel consumption figures are suitable for approximate design of mono mode systems, for example.

Subject to the heated living space

The table values give an approximate specific heat load per m² of heated living space.

$$Q_N = \text{living space} * \text{watt/m}^2$$

Family homes (existing buildings)

Thermal insulation of the external wall	Window	Storeys	Watts per m ² living area
No	Single-glazed	1	160
No	Single-glazed	2	140
No	Double-glazed	1 - 2	100
Yes	Double-glazed	1 - 2	80
Yes	Insulation glazing	1 - 2	50

Subject to oil consumption

The average oil consumption of the last five years allows an approximate calculation of the heat load.

$$Q_N = \frac{B_a * \eta * H_u}{b_{VH}}$$

Q_N	Heat load [kW]
B_a	Annual oil consumption [l] (Average consumption of the last 5 years, minus 75 l oil per person for DHW heating.)
η	Seasonal efficiency ($\eta = 0.7$)
H_u	Net calorific value of fuel oil [10 kWh/l]
b_{VH}	Hours of full utilisation (average value 1800 h/a)

Brief formula:

$$Q_N = \frac{B_a}{250}$$

Subject to gas consumption

The average gas consumption of the last five years allows an approximate calculation of the heat load:

$$Q_N = \frac{B_a * \eta}{b_{VH}}$$

Q_N	Heat load [kW]
B_a	Annual gas consumption [kWh]
η	Seasonal efficiency ($\eta = 0.8$)
b_{VH}	Hours of full utilisation (average value 1800 h/a)

Heat pump principles

Heating surface temperature

Heating surface temperature

With regard to possible applications and heat pump operating mode, the flow temperature of the heating system is significant.

The changeover point of the heat pump is based on both the heating output of the heat pump and the sizing of the heating surfaces.

Existing radiator systems have generally been designed for a flow temperature of $>55\text{ }^{\circ}\text{C}$.

Through subsequent thermal insulation or oversizing of heating surfaces, a flow temperature of just $\leq 60\text{ }^{\circ}\text{C}$ is required.

To enable economic mono mode, radiator heating surfaces are sized for a flow temperature of $\leq 55\text{ }^{\circ}\text{C}$.

Example

Down to what outside temperature can a heating system with a flow temperature of $+75\text{ }^{\circ}\text{C}$ (heating curve B) be operated with a heat pump operating with a flow temperature of up to $+60\text{ }^{\circ}\text{C}$?

In this example, the point of intersection between the heating curve B and the max. heat pump flow temperature of $+60\text{ }^{\circ}\text{C}$ arrives at an outside temperature of $-4\text{ }^{\circ}\text{C}$. The application limit of this heat pump therefore lies at an outside temperature of $-4\text{ }^{\circ}\text{C}$ because of the heat distribution system.

Practical experience has shown that the heating limit extends to a lower temperature range through external and internal energy recovery. This means that the heat pump accounts for a higher percentage of the seasonal performance.

Rule of thumb

The lower the flow temperature of the heating system, the higher the COP of the heat pump.

Flow temperatures for the corresponding outside temperatures

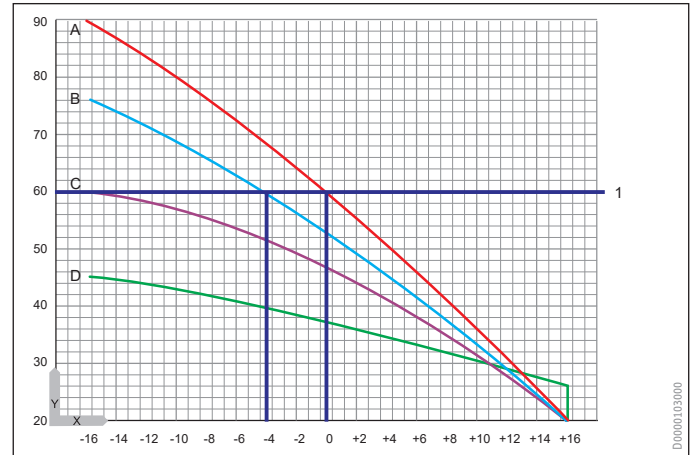

- X Outside temperature [$^{\circ}\text{C}$]
- Y Heating flow temperature [$^{\circ}\text{C}$]
- 1 Heat pump flow temperature [$^{\circ}\text{C}$]
- A-D Flow temperature curves

The diagram gives the following changeover points to the second heat generator based on the flow temperature:

Curve	Flow temperature $^{\circ}\text{C}$	Changeover point $^{\circ}\text{C}$	Operating mode
A	90	0	Dual mode
B	75	-4	Dual mode
C	<60	-	Mono mode
D	<60	-	Mono mode

Heat pump principles

Design - Fixspeed, air source heat pumps

Example design of air source heat pumps

The diagram shows the connection between the heat load of the building and the heating output of the heat pump.

The intersection of the curves provides the dual mode point (start point for the second heat generator). To cover a large seasonal proportion of the heat load with the heat pump, the dual mode point in mono energetic operating mode should be at an outside temperature of between -3 °C and -7 °C.

Sizing example

The example is a house with a heat demand of 11.0 kW.

The heat distribution system is an area heating system with a system temperature of 40/30 °C. The system temperature is based on a standard outside temperature of -14 °C.

The dual mode point should lie between -3 °C and -7 °C.

Result

The required heating output of the heat pump in the case of underfloor heating with a blocking time of 4 hours is:

$$(Q_{H,AP}) / (d - t_{SD}) = Q_{WP,erf}$$

$$(11.0 \text{ kW} * 24 \text{ h}) / (24 \text{ h} - 4 \text{ h}) = 13.2 \text{ kW}$$

A heat pump is selected, which independently covers the heat demand down to an outside temperature of -7 °C and achieves an annual heating proportion of 98 %.

Example design of air source heat pump

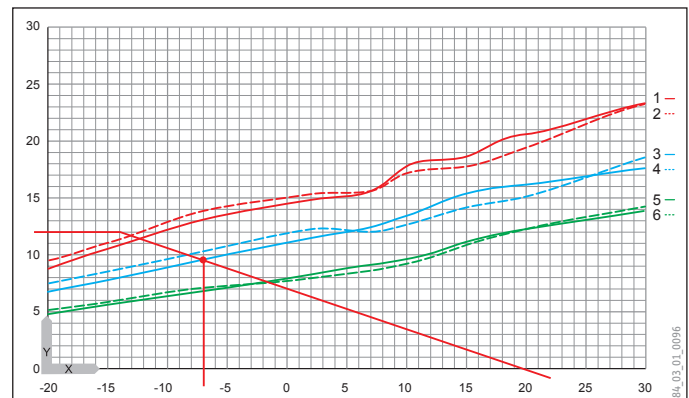

X	Air inlet temperature [°C]
Y	Heating output [kW]
1	Example HP 1, T _V 35 °C
2	Example HP 1, T _V 50 °C
3	Example HP 2, T _V 35 °C
4	Example HP 2, T _V 50 °C
5	Example HP 3, T _V 35 °C
6	Example HP 3, T _V 50 °C

Annual coverage by the heating heat pump

Dual mode point °C	Parallel (mono energetic) mode				
	Coverage according to climate zone				
	-10 °C	-12 °C	-14 °C	-16 °C	-18 °C
-12	1.00	1.00	1.00	0.99	0.98
-10	1.00	1.00	0.99	0.98	0.97
-8	1.00	0.99	0.98	0.97	0.96
-6	0.99	0.99	0.98	0.97	0.95
-4	0.99	0.98	0.97	0.95	0.93
-2	0.98	0.96	0.94	0.92	0.90
0	0.96	0.93	0.90	0.87	0.85
+2	0.92	0.88	0.85	0.81	0.77
+4	0.87	0.83	0.79	0.74	0.69
+6	0.81	0.77	0.72	0.67	0.62
+8	0.75	0.71	0.65	0.59	0.52

Design of the heat pump with blocking times

The heat load of the building must be taken into account over 24 hours. For the design of the heat pump system, any blocking times must be taken into consideration by the power supply utility.

$$Q_{WP,erf} = (Q_{H,AP} + Q_{DP,ges} + Q_{sonst}) / (d - t_{SD})$$

$Q_{WP,erf}$	Required heat pump output
$Q_{H,AP}$	Daily amount of energy for heating
$Q_{DP,ges}$	Daily amount of energy for DHW heating
Q_{sonst}	Daily amount of energy for other applications
d	Day duration (24 h)
t_{SD}	Daily total of blocking times"

Air source heat pumps

In air source heat pumps, the heating output is subject to the outside temperature. The disadvantage of this is that when the outside temperature drops, the heating output of the heat pump falls but the heat load also rises.

Air source heat pumps are designed for mono energetic operation.

Heat pump principles

Design - Fixspeed, ground source heat pumps

Design of the heat pump with blocking times

The heat load of the building must be taken into account over 24 hours. For the design of the heat pump system, any blocking times must be taken into consideration by the power supply utility.

$$Q_{WP,erf} = (Q_{H,AP} + Q_{DP,ges} + Q_{sonst}) / (d - t_{SD})$$

$Q_{WP,erf}$	Required heat pump output
$Q_{H,AP}$	Daily amount of energy for heating
$Q_{DP,ges}$	Daily amount of energy for DHW heating
Q_{sonst}	Daily amount of energy for other applications
d	Day duration (24 h)
t_{SD}	Daily total of blocking times"

Ground source heat pumps

The temperature of the heat source remains almost constant at approx. +10 °C all year round. This means that the heat pump heating output too is almost constant.

Ground source heat pumps are generally designed for mono mode operation.

Example design of a ground source heat pump

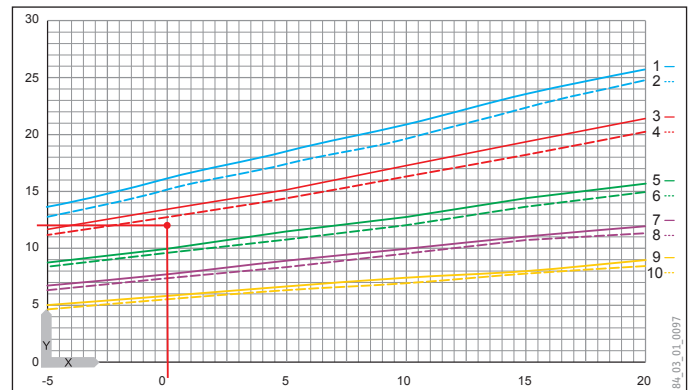

Diagram shows curves of various heat pumps in a series.

Heat pump principles

Design - Fixspeed, ground source heat pumps

Design of the heat pump with blocking times

The heat load of the building must be taken into account over 24 hours. For the design of the heat pump system, any blocking times must be taken into consideration by the power supply utility.

$$Q_{WP,erf} = (Q_{H,AP} + Q_{DP,ges} + Q_{sonst}) / (d - t_{SD})$$

- $Q_{WP,erf}$ Required heat pump output
- $Q_{H,AP}$ Daily amount of energy for heating
- $Q_{DP,ges}$ Daily amount of energy for DHW heating
- Q_{sonst} Daily amount of energy for other applications
- d Day duration (24 h)
- t_{SD} Daily total of blocking times"

Ground source heat pumps with groundwater as the heat source

The temperature of the heat source remains almost constant at approx. +10 °C all year round. This means that the heat pump heating output too is almost constant.

In heat source systems with an intermediate heat exchanger, the heat pump inlet temperature is approx. 3 K lower.

Example design of a ground source heat pump with water as the heat source

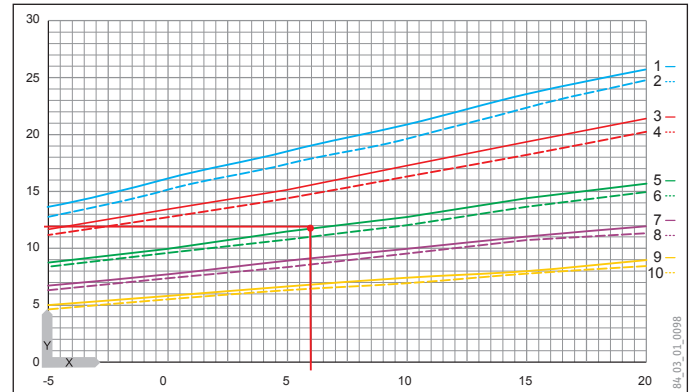

Diagram shows curves of various heat pumps in a series.

- X Heat source temperature [°C]
- Y Heating output [kW]
- 1 Heat pump 1, T_V 35 °C
- 2 Heat pump 1, T_V 50 °C
- 3 Heat pump 2, T_V 35 °C
- 4 Heat pump 2, T_V 50 °C
- 5 Heat pump 3, T_V 35 °C
- 6 Heat pump 3, T_V 50 °C
- 7 Heat pump 4, T_V 35 °C
- 8 Heat pump 4, T_V 50 °C
- 9 Heat pump 5, T_V 35 °C
- 10 Heat pump 5, T_V 50 °C

Heat pump principles

Design - Fixspeed, water source heat pumps

Water source heat pumps

The temperature of the heat source remains almost constant at approx. +10 °C all year round. This means that the heat pump heating output too is almost constant.

Depending on the specific product, it is possible to connect the heat source system directly to the heat pump.

Authorisation by the water board is required for heat extraction from the groundwater.

Outside of water protection zones, authorisation is generally granted. Authorisation is linked to specific conditions, e.g. a maximum draw-off volume or a water analysis.

The draw-off volume depends on the heating output.

To prevent iron ochre sedimentation in the heat source system, the groundwater should not contain any matter that can settle.

To utilise groundwater as a heat source, the following prerequisites must be met:

- » Sufficient water volume
- » Water quality (analysis)
- » Authorisation by the relevant water board
- » Supply well and return well

Water source heat pumps are designed as mono mode appliances.

Example output diagram

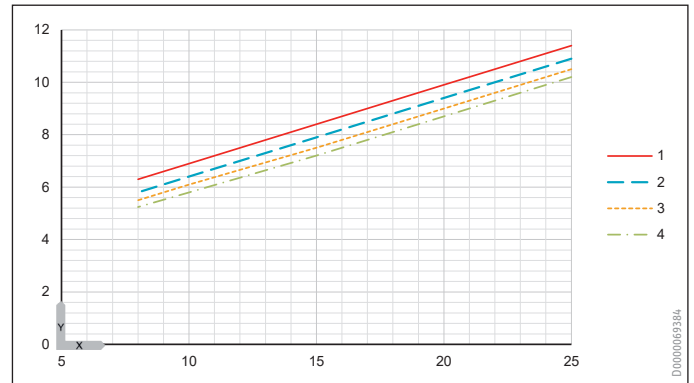

x	Inlet temperature of the WQA medium [°C]
y	Heating output [kW]
1	Flow temperature 35 °C
2	Flow temperature 45 °C
3	Flow temperature 50 °C
4	Flow temperature 60 °C

Heat pump principles

Design - inverter, air source heat pump

Air source heat pumps (output-dependent control)

The continuous output-dependent control of the compressor matches the heating output to the building heat load.

In view of the consistently high heating output, air source heat pumps with inverter technology can be operated in mono mode.

Mono energetic operating mode down to the dual mode point $\leq -5\text{ }^{\circ}\text{C}$ is also possible.

The output-dependent control of the compressor results in numerous benefits:

- » Matching of the heat pump output to the current building heat load
- » Avoidance of heat pump cycling
- » Longer runtimes therefore less start-up losses
- » Increased efficiency of the entire system
- » Lower sound power level in partial load operation
- » Possibility for use of high efficiency, variable speed pumps in the periphery
- » Compact design
- » Less effort to defrost the heat pump evaporator

The output-dependent control of a heat pump is limited by the minimum speed of the compressor. This results in a minimum output, which increases as the outside temperature rises. This should be taken into consideration during the system design phase, particularly for partial load operation.

If too large a heat pump with output-dependent control is used, it cannot achieve its full potential. Minimum and maximum application limits therefore apply to heat pumps with output-dependent control.

Example design

Mono mode operation

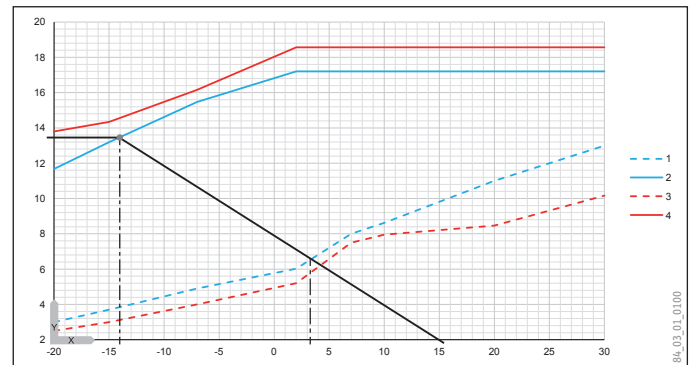

Example: Standard outside temperature = $-14\text{ }^{\circ}\text{C}$

X	Outside temperature [$^{\circ}\text{C}$]
Y	Heating output [kW]
1	min. W35
2	max. W35
3	min. W55
4	max. W55

Example design

Mono energetic operation

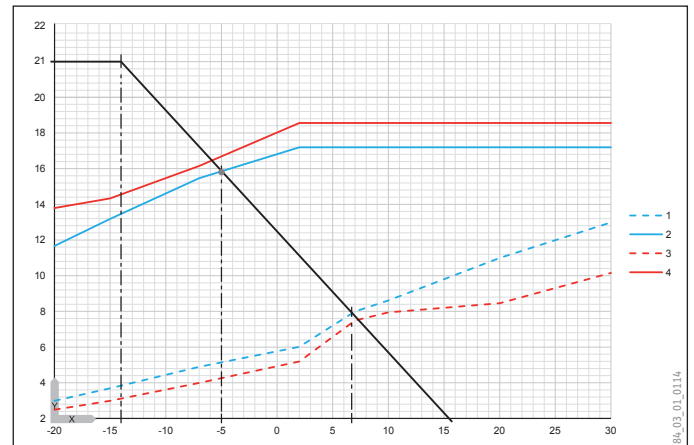

Example: Standard outside temperature = $-14\text{ }^{\circ}\text{C}$

X	Outside temperature [$^{\circ}\text{C}$]
Y	Heating output [kW]
1	min. W35
2	max. W35
3	min. W55
4	max. W55

Heat pump principles

Design - inverter, ground source heat pumps

Brine source heat pumps (output-dependent control)

The continuous output-dependent control of the compressor matches the heating output to the building heat load.

Ground source heat pumps with inverter technology can be used in mono mode for heating and DHW.

The output-dependent control of the compressor results in numerous benefits:

- » Matching of the heat pump output to the current building heat load
- » Avoidance of heat pump cycling
- » Longer runtimes therefore less start-up losses
- » Increased efficiency of the entire system
- » Lower sound power level in partial load operation
- » Possibility for use of high efficiency, variable speed pumps in the periphery
- » Compact design

The output-dependent control of a heat pump is limited by the minimum speed of the compressor. This results in a minimum output, which increases as the brine temperature rises. This should be taken into consideration during the system design phase, particularly for partial load operation.

If too large a heat pump with output-dependent control is used, it cannot achieve its full potential.

Minimum and maximum application limits therefore apply to heat pumps with output-dependent control.

Peripheral pressure drops must be calculated and cross checked with the residual head of the integral source pump.

Example output diagram

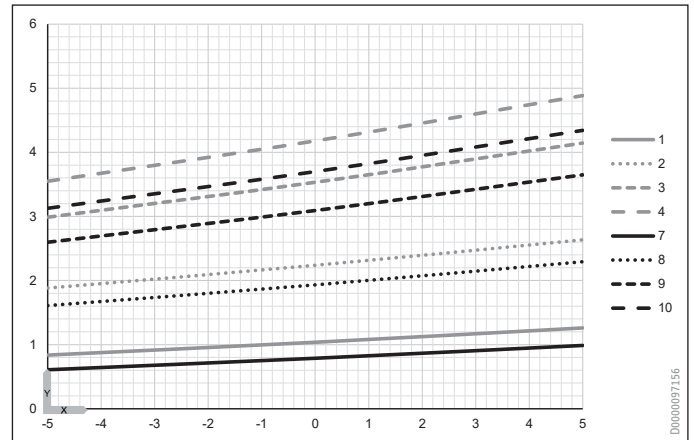

X	Inlet temperature WQA [°C]
Y	Cooling capacity [kW]
1	Min. frequency, B0/W35
2	40 Hz frequency, B0/W35
3	60 Hz frequency, B0/W35
4	Max. frequency, B0/W35
7	Min. frequency, B0/W55
8	40 Hz frequency, B0/W55
9	60 Hz frequency, B0/W55
10	Max. frequency, B0/W55

Notes

Heat pump principles

Electrical connection - Germany

Power supply

A heat pump can be operated as controllable consumer equipment to ensure more favourable grid charges.

When using heat pumps for building heating, the power supply utility (PSU) must give authorisation.

The connection conditions for the specified appliance data must be obtained from the relevant power supply utility. It is of particular interest to check whether mono energetic heat pump operation is feasible in your region.

Information about the basic charge and energy rate, the option to use electricity at an off-peak economy tariff and possible blocking times is important for the design process.

The local power supply utility will be a valuable contact in these matters.

Application procedures

The following details are required to assess the effects of heat pump operation on the grid of the local power supply utility:

- » User address
- » Location of the heat pump
- » Demand type according to general tariffs for domestic, agriculture, commercial, professional and other demand
- » Intended operating mode of the heat pump
- » Heat pump manufacturer
- » Heat pump type
- » Connected electrical load in kW
- » Maximum starting current in amps (information from manufacturer)
- » Heat load of the building in kW

Requirements for the electrical installation of heat pumps

- » The technical connection conditions of the relevant power supply utility must be observed.
- » For information regarding the necessary switching and metering equipment, contact the power supply utility.

Cable cross-sections

Depending on the fuse protection and line routing, the following cable cross-sections must be used in accordance with VDE 0298-4.

Fuse protection A	Cable cross-section mm ²	Conditions
10	1.5	
16	1.5	With only two live cores and routing on a wall or in an electrical conduit on a wall
16	2.5	
20	4.0	
20	2.5	When routing on a wall or in an electrical conduit on a wall
25	4.0	When routing a multi core cable on a wall or in an electrical conduit on the wall
25	6.0	When routing in a wall
35	10.0	
50	16.0	

Heat pump principles

Electrical connection - Germany

Installation example with ripple control receiver

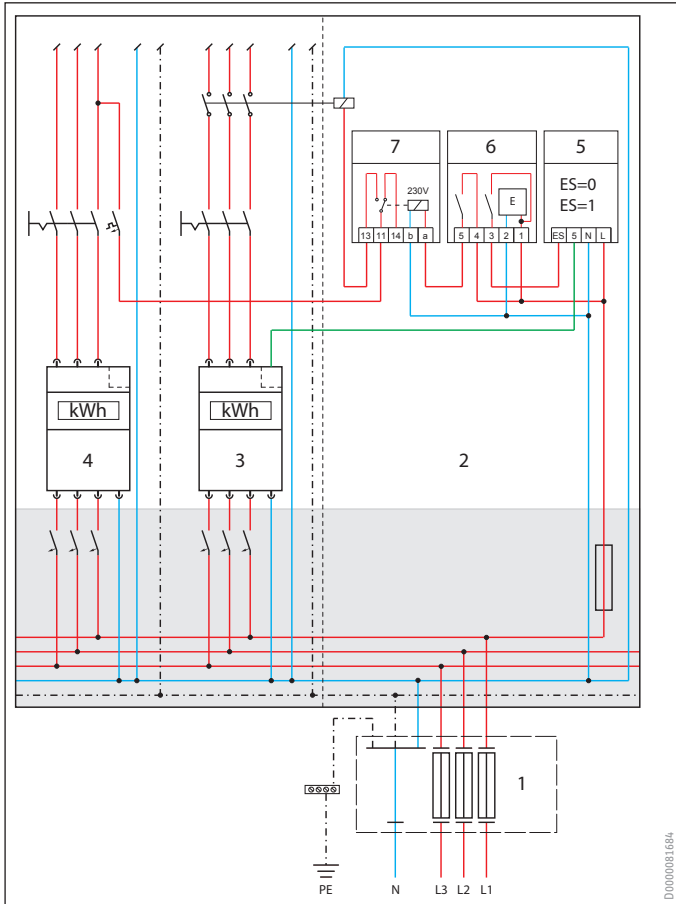

- 1 Building junction box
 - 2 Meter cabinet
 - 3 eHZ heat pump
 - 4 eHZ household
 - 5 Coupling relay
 - 6 TR receiver
 - 7 POWER-OFF
- ES=0 / tariff 1
ES=1 / tariff 2

Installation example without power-OFF

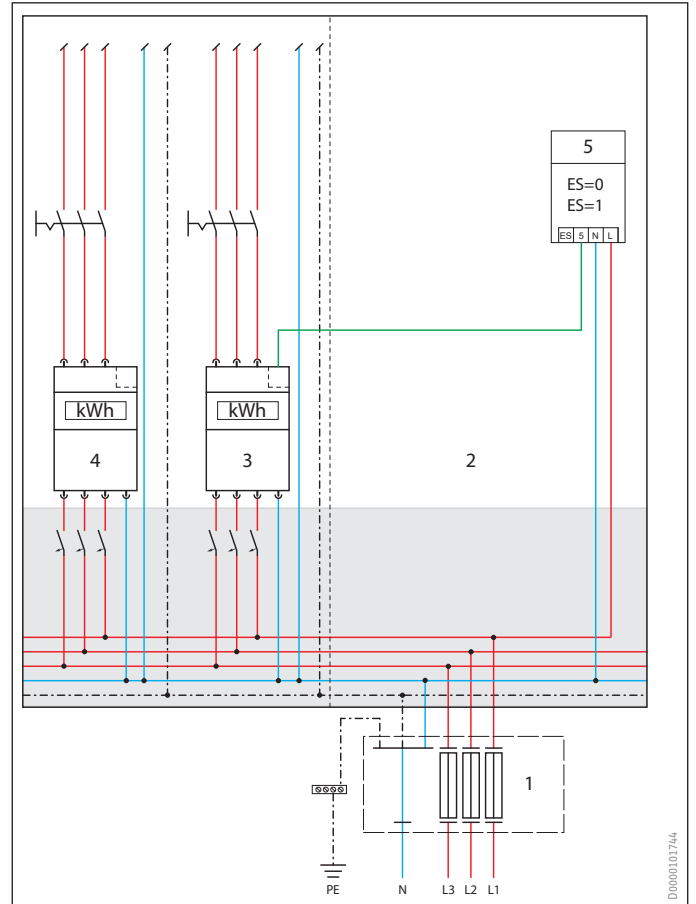

- 1 Building junction box
 - 2 Meter cabinet
 - 3 eHZ heat pump
 - 4 eHZ household
 - 5 Coupling relay
- ES=0 / tariff 1
ES=1 / tariff 2

Heat pump principles

Heating water quality

Water quality

The composition and therefore the quality of the heating water is important with regard to scaling, corrosion and the functioning of the heating system.

Correct operation and suitable water quality reduce the probability of damage occurring.

Damage occurs among other things as a result of scaling, limescale deposits and corrosion.

The quality of the heating water affects the components installed in the water circuit. Furthermore, the water quality affects the functionality of the entire system.

Reducing the oxygen concentration in all parts of the hot water heating system is essential for the water quality of the heating system.

The fundamental quality of the fill and top-up water is regulated by EN 12828 and VDI 2035.

VDI 2035 constitutes the current status of technology regarding water treatment. The guideline regulates the requirements for water treatment when filling and topping up heating systems.

According to VDI 2035, the heating water must be suitable for and compatible with all components of the heating system. If the heating water is also used for DHW heating, the requirements for protection of drinking water in accordance with DIN 1988-100 or EN 1717 must be observed.

The fill and top-up water must be treated. Treated heating water is softened or desalinated water to which no chemicals are added. During the treatment of heating water, the specifications of the heat pump manufacturer must be observed.

The type of water treatment varies depending on the use of different metallic materials and their combination with plastics.

In the case of aluminium fittings frequently used in heating systems, there are special requirements for the pH value. The corrosion behaviour of aluminium materials is primarily determined by the pH value of the heating water. The heating water must be limited to a pH value of 8.2 to 8.5. Desalination is preferable to softening. In the case of non-aluminium fittings, softening is preferred.

According to VDI 2035, the permissible water hardness for the fill and top-up water depends on:

- » Overall hardness
- » Minimum individual output of the heat generator

Softening is recommended particularly when using electric heating cartridges as an electric emergency/auxiliary heater for heat pumps, for example. Softening prevents limescale deposits on the heating elements. Limescale flaking off from heating elements can be deposited in the downstream system. Pumps, valves and check valves may become clogged.

Scaling on heat exchangers and fittings lead to both considerable energy losses and malfunctions in the entire system.

According to VDI 2035, drinking water should be used as the fill and top-up water. If this does not fulfil the requirements in accordance with table 1, it should be treated accordingly. Analysis values of the local water supplier will help with to assess this. It is also important to ensure that the volume of fill and top-up water does not exceed three times the water capacity of the system during the service life, otherwise the probability of corrosion damage increases.

The overall hardness of the heating water must be < 3 °dH.

Depending on the system configuration, VDI 2035 may specify higher requirements. The water capacity of the entire system and the lowest individual heating output of the installed heat generator must be taken into consideration.

In systems with a water capacity of more than 40 l per kW, a maximum total hardness of the heating water of 0.3 °dH is required.

When using an electric emergency/auxiliary heater with 2.6 kW, from a system volume of > 104 l, the total hardness must be < 0.3 °dH.

Heat pump principles

Heating water quality

Example:

System volume = 125 litres

Total heating output = approx. 5 kW, with underfloor heating

Lowest specified output = 2.6 kW

Specific system volume = system volume ÷ lowest output = 125 l / 2.6 kW = 48 l/kW

The regional water supply utility (WSU) reports a total hardness of 3.57 mol/m³ (≈20 °dH) in the relevant supply area.

According to the table, the fill and top-up water must be softened to 0.05 mol/m³ (≈0.3 °dH).

Standard values for the fill, top-up and heating water

Fill and top-up water, as well as heating water, subject to heating output						
Total heating output kW	Total alkaline earths					
	Specific system volume in l/kW heating output					
	≤20 mol/m ³ °dH		>20 - ≤40 mol/m ³ °dH		>40 mol/m ³ °dH	
≤50	None	None	≤3.0	16.8	<0.05	0.3
≤50	≤3.0	16.6	≤1.5	6.4	<0.05	0.3
>50 - ≤200	≤2.0	11.2	≤1.0	5.6	<0.05	0.3
>200 - ≤600	≤1.5	8.4	<0.05	0.3	<0.05	0.3
>600	<0.05	0.3	<0.05	0.3	<0.05	0.3

Fill and top-up water, as well as heating water, not subject to heating output

Operating mode	Electrical conductivity in µS/cm
With low salt content	>10 - ≤100
Saline	<100 - ≤1500
Appearance	
Clear, free from sedimentable substances	
Materials in the system	pH value
Without aluminium alloys	8.2 - 10.0
With aluminium alloys	8.2 - 9.0

Recommended softening process

There are various processes for producing treated fill and top-up water. Softening should ideally be carried out on the basis of ion exchanger technology.

Softening

- » Salinity unchanged
- » Free from Mg, Ca (softened)
- » Buffer system unchanged
- » pH value unchanged
- » No additional measures for water conditioning required

Conventional softening is achieved by means of a sodium exchanger. Calcium and magnesium ions are replaced with sodium ions. No changes are made to the water chemistry.

Electrical conductivity and pH value remain unchanged so that no additional measures for water conditioning are required.

No inhibitors or additives should be introduced into the heating water.

Heat pump principles

Heating water softening

Softening cartridges

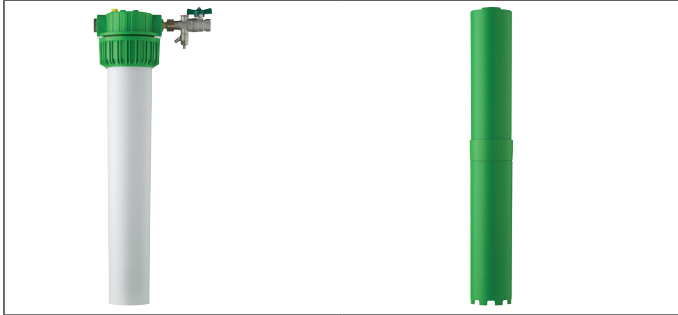

Sizing when filling the system for the first time

The number of cartridges to fill the system for the first time is calculated using the following formula:

$$P_{Anz} = \frac{V_{Anl} \cdot (\text{°dH}_{Ist} - \text{°dH}_{Soll})}{K_{WWM}}$$

P_{ANZ}	Number of cartridges
V_{ANL}	System volume
K_{WWM}	Soft water capacity in litres * °dH
°dH_{IST}	Actual water hardness
°dH_{SOLL}	Target water hardness

Use the corresponding limit from the "Total hardness limits" table to calculate the number of cartridges.

Sizing example – filling for the first time:

V_{ANL}	= 200 l
°dH_{ist}	= 20 °dH
°dH_{soll}	= 0.3 °dH
K_{WWM}	= 6000 l · °dH

$$P_{Anz} = \frac{200 \text{ l} \cdot (20 \text{ °dH} - 0,30 \text{ °dH})}{6.000 \text{ l} \cdot \text{°dH}} = 1,64 \cong 2,00$$

Result: Two cartridges are required for initial filling.

Cartridge service life

The achievable soft water quantity and the top-up quantity enable the service life of a cartridge to be calculated. The annual top-up quantity is 10 % of the system volume. The top-up water must be softened to 0 °dH.

The amount of softened water is calculated using the following formula.

$$V_{WW} = \frac{K_{WWM}}{(\text{°dH}_{Ist})}$$

V_{WWM}	Volume of softened water
K_{WWM}	Soft water capacity in litres * °dH
°dH_{ist}	Total water hardness

The service life of a cartridge is determined taking into consideration the annual top-up quantity.

$$a = \frac{V_{WWM}}{V_{Anl} \cdot 0,10}$$

Example calculation

K_{WWM}	= 6000 l · °dH
°dH_{ist}	= 20 °dH
V_{Anl}	= 500 l

$$V_{WW} = \frac{6.000 \cdot \text{°dH}}{(20 \text{ °dH})} = 300 \text{ l}$$

$$a = \frac{300 \text{ l}}{500 \text{ l} \cdot 0,10} = 6,0$$

A system volume of 2000 l and a soft water quantity of 300 l results in a service life of 1.5 years.

Heat pump principles

Heating water softening

Total volume of softened water

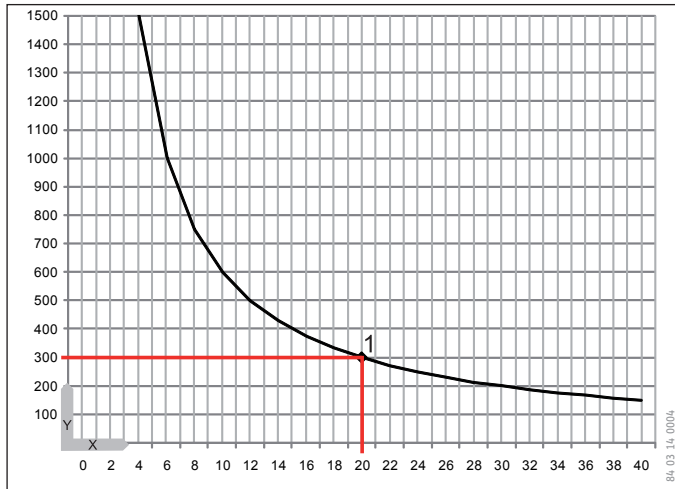

- x Total water hardness in °dH
- y Amount of softened water in litres
- 1 Example: Amount of softened water at 20 °dH

Notes

Heat pump principles

Heating cost calculation - Germany

Basics

Efficiency calculations are used to compare various heat generators and system concepts. Efficiency calculations form the basis for an objective decision. All costs must be included and divided into relevant cost groups. The influence of various cost types can be analysed separately.

Cost calculation to VDI 2067

The Guideline concerns the viability calculation of technical services for buildings; it uses the annuity method. The costs are divided into four groups.

- » Energy demand of heated and air-conditioned buildings.
- » Energy expenditure of the transfer of use for DHW heating and drinking water heating.
- » Energy expenditure in distribution.
- » Energy expenditure of the creation of heat pump systems and boiler systems.

The calculation takes into account costs, interest and price developments dynamically over a period in the future.

The required interest accumulation or annuity factors are specified and added to the annual constant investment totals over the period under consideration.

Various models, types and financial subsidies offer a wide range for the use of heat pumps.

The following example cost calculation is based on the terms and definitions explained here, as well as the annuity method.

Mono mode as well as dual mode parallel operation are indicated in the comparison of different heat pumps. The latter has been shown in this example in mono energetic form.

The example shows, among other things, that the combination of basic and peak load heat generators may be worthwhile.

The relationship between the base and peak load, as well as the resulting coverage are crucial.

Total costs per year

Example:

Annual cost breakdown

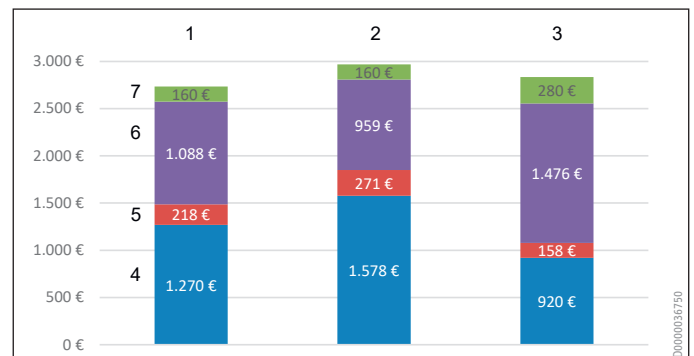

- 1 Air source heat pump
- 2 Ground source heat pump
- 3 Gas condensing boiler
- 4 Capital costs
- 5 Maintenance costs
- 6 Energy costs
- 7 Maintenance costs

Heat pump principles

Heating cost calculation - Germany

Example cost calculation according to VDI 2067

Heat load of the building in kW		8	8	8
Heat demand for heating in kWh		13.946	13.946	13.946
Number of occupants		4	4	4
Heat demand for DHW in kWh		3.954	3.954	3.954
Operating mode of the heating heat pump		Mono energetic	Mono mode	-
Electric emergency/auxiliary heater		Power	No	-
Solar backup		No	No	DHW
Period under consideration in years		20	20	20
Interest rate in %		1.50	1.50	1.50
Annuity factor (interest and amortisation)		0.0582	0.0582	0.0582
		Air source heat pump	Ground source heat pump	Gas condensing with solar thermal system
1. System details				
Energy price for heating	Ct/kWh	21.00	21.00	6.90
Domestic energy price	Ct/kWh	30.00	30.00	30.00
Standing charge p.a.	€	60.00	60.00	170.00
Efficiency/seasonal performance factor for heating		4.37	5.18	0.95
Efficiency/seasonal performance factor for DHW		3.13	3.23	0.80
Dual mode point	°C	-6.5	-9.2	
Heating coverage	%	0.99	1.00	1.00
DHW coverage	%	1.00	1.00	0.50
Solar/heating coverage	%			
Solar heating/DHW coverage	%			0.50
2. Investment costs				
Heat generator complete	€	12.700	12.600	4.000
Heating system	€			
Heating installation	€	2.000	2.000	2.000
Electrical installation	€	1.500	1.500	500
DHW cylinder	€	4.600		2.000
DHW installation	€	1.000	1.000	1.000
Gas connection	€			1.300
Chimney	€			2.000
Heat source system	€		10.000	
Solar thermal system	€			3.000
Total	€	21.800	27.100	15.800
3. Capital costs				
Capital costs	€	1.270	1.578	920
Maintenance	€	218	271	158
Total	€	1.488	1.849	1.078
4. Operational costs				
Maintenance	€	160	160	210
Flue gas inspector	€			70
Total	€	160	160	280
5. Consumption costs				
Heating				
Annual energy demand	kWh	13.946	13.946	13.946
Energy consumption, heating	kWh	3.169	2.691	14.680
Energy consumption of electric emergency/auxiliary heater	kWh	105	9	
Annual auxiliary energy demand	kWh	250	250	250
DHW				
Annual energy demand	kWh	3.954	3.954	3.954
Energy consumption, DHW	kWh	1.262	1.223	2.471
Energy consumption of electric emergency/auxiliary heater	kWh			
Solar				
Energy yield, heating	kWh			
Energy yield, DHW	kWh			1.977
Energy consumption, solar	kWh			160

Heat pump principles

Heating cost calculation - Germany

Results			
Total energy consumption	kWh	4.786	17.561
Total CO2 emissions	kg	2.680	4.346
System energy costs	€	1.088	1.476
Total system costs	€	2.735	2.835
Primary energy factor		1.80	1.10
Primary energy demand	kWh	8.615	19.604

Amortisation

Rate of price increase	Air source heat pump		Ground source heat pump		Gas condensing		Interest on capital	Differential costs, air source heat pump/gas		Differential costs, ground source head pump/gas							
	2.0 %	2.0 %	2.0 %	2.0 %	3.0 %	2.0 %		1.5 %									
Capital differential																	
Cumulative return													6.000 €				11.300 €
	En-ergy costs	Oper-ating costs	Total	En-ergy costs	Oper-ating costs	Total	En-ergy costs	Oper-ating costs	Total	Pres-ent value factor	Cost dif-ferential	Pres-ent value		Cost dif-ferential	Pres-ent value		
1	1.088	378	1.466	959	431	1.390	1.476	438	1.914	0.985	449	442	5.558	525	517	10.783	
2	1.109	386	1.495	978	440	1.418	1.521	447	1.967	0.971	473	459	5.099	550	534	10.250	
3	1.131	393	1.525	998	448	1.446	1.566	456	2.022	0.956	497	476	4.623	576	551	9.699	
4	1.154	401	1.555	1.018	457	1.475	1.613	465	2.078	0.942	523	493	4.131	603	568	9.130	
5	1.177	409	1.586	1.038	467	1.504	1.662	474	2.136	0.928	549	510	3.621	631	586	8.544	
6	1.201	417	1.618	1.059	476	1.535	1.712	484	2.195	0.915	577	528	3.093	661	604	7.940	
7	1.225	426	1.650	1.080	485	1.565	1.763	493	2.256	0.901	606	546	2.547	691	623	7.318	
8	1.249	434	1.683	1.101	495	1.597	1.816	503	2.319	0.888	635	564	1.983	722	641	6.676	
9	1.274	443	1.717	1.123	505	1.628	1.870	513	2.383	0.875	666	583	1.400	755	660	6.016	
10	1.300	452	1.751	1.146	515	1.661	1.926	523	2.450	0.862	698	602	798	789	680	5.336	
11	1.326	461	1.787	1.169	525	1.694	1.984	534	2.518	0.849	732	621	177	824	699	4.637	
12	1.352	470	1.822	1.192	536	1.728	2.044	545	2.588	0.836	766	641	-463	860	719	3.917	
13	1.379	479	1.859	1.216	547	1.763	2.105	555	2.661	0.824	802	661	-1.124	898	740	3.177	
14	1.407	489	1.896	1.240	558	1.798	2.168	567	2.735	0.812	839	681	-1.805	937	761	2.417	
15	1.435	499	1.934	1.265	569	1.834	2.233	578	2.811	0.800	877	702	-2.507	977	782	1.635	
16	1.464	509	1.972	1.291	580	1.871	2.300	589	2.890	0.788	917	723	-3.230	1.019	803	832	
17	1.493	519	2.012	1.316	592	1.908	2.369	601	2.971	0.776	959	744	-3.974	1.063	825	7	
18	1.523	529	2.052	1.343	604	1.946	2.440	613	3.054	0.765	1.001	766	-4.740	1.107	847	-840	
19	1.553	540	2.093	1.370	616	1.985	2.514	626	3.139	0.754	1.046	788	-5.528	1.154	870	-1.710	
20	1.584	551	2.135	1.397	628	2.025	2.589	638	3.227	0.742	1.092	811	-6.339	1.202	893	-2.602	

Consumption costs: Include fuel costs, meter hire fees and standard price

Operating costs: Include maintenance costs, servicing and flue gas inspector costs

Capital differential: Differential of investments for heat pump system

Cost differential: Differential of running costs for heat pump system

Cumulative return flow: Differential of running costs for heat pump system

Present value factor: The present value factor is a financial calculation factor.

The present value factor applies interest to the segments g of a series of payments, taking the rate of interest and compound interest into consideration, and adds the present values together.

Present value: The value of one or more capital sums due in the future in relation to the reference time.

The present value is the current value of future receipts or payments as a result of discounting.

Heat pump principles

Buffer cylinder

Buffer cylinder

For fault-free operation, heat pumps require a minimum heating water flow rate. To ensure fault-free operation of the heat pump, the use of buffer cylinder must be checked.

Buffer cylinders are used in particular for hydraulic separation of different flows in the heat pump circuit and heating circuit. For example, if the flow rate in the heating circuit is reduced via thermostatic valves, the flow rate in the heat pump circuit remains constant.

Depending on the heat pump type, in spring and autumn and in partial load operation, for example in radiator heat distribution systems, cycling is possible. Frequent cycling of heat pumps reduces the system efficiency and has a negative effect on the expected service life of the heat pump. Cycling is avoided by means of an appropriately sized buffer cylinder volume.

Air source heat pumps require a heating water volume large enough for defrosting.

Subject to the country, heat pumps can be blocked at peak load times by the power supply utility. For radiator heating systems that cool down rapidly, the buffer cylinder volume is selected so that the heat content stored therein is sufficient to cover any blocking times.

In conjunction with a photovoltaic system for self-consumption, a buffer cylinder enables surplus energy to be stored.

Parallel buffer cylinder

Buffer cylinders incorporated parallel to the heat pump achieve hydraulic separation between the heat pump and the heating circuits.

This ensures the minimum flow rate of the heat pump at all times irrespective of the flow rate in the heating circuit.

Hydraulic separation is always required when using multiple heating circuits.

A buffer charging pump is required for charging a buffer cylinder. Systems with parallel buffer cylinders are hydraulically robust. This enables requirements such as multiple heating circuits with different temperature levels or incorporating additional heat generators to be met.

We recommend using parallel buffer cylinders.

Heat pump with buffer cylinder connected in parallel

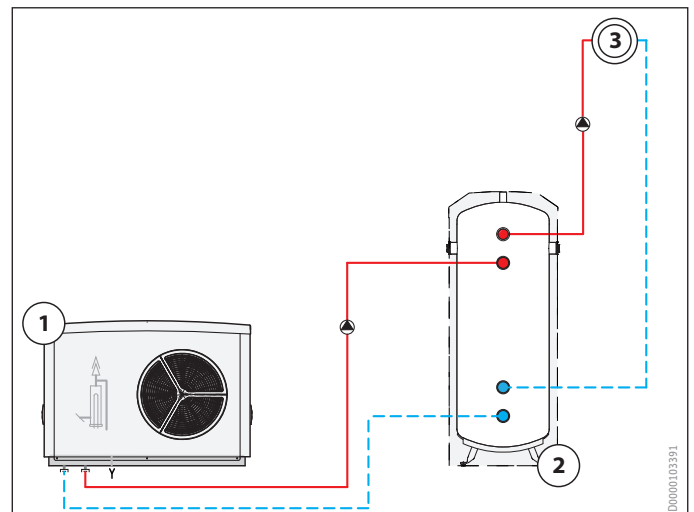

- 1 Heat pump
- 2 Buffer cylinder
- 3 Heating circuit

Heat pump principles

Buffer cylinder

Hybrid cylinder

Hybrid cylinders combine multiple functions in a single appliance. The available indoor space for the heating system is generally small.

In this case, hybrid cylinders can be used, which integrate heating and DHW cylinders with various concepts into one shared cylinder or appliance.

Instantaneous water cylinder

Hybrid cylinders can be configured as instantaneous water cylinders, in which DHW is heated according to the instantaneous water heating principle with a large heat exchange surface area.

The internal indirect coil for DHW heating is surrounded by heating water, so that multiple heating circuits can also be supplied in addition to DHW heating.

In instantaneous water cylinders, DHW heating is carried out particularly hygienically, as only a low DHW quantity is stored, thereby ensuring a high exchange of DHW.

Integral and system cylinder

In integral and system cylinders, hydraulically separated buffer and DHW cylinders are installed in a single shared casing.

Integral cylinders can also be used for cooling.

Heat pump with instantaneous water cylinder

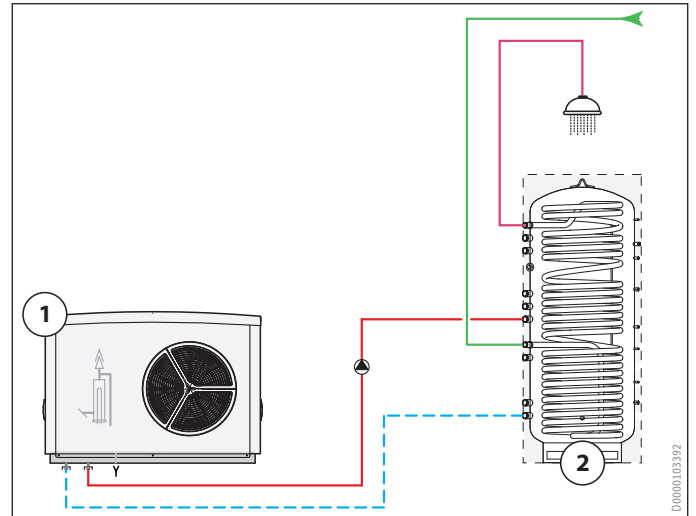

- 1 Heat pump
- 2 Instantaneous water cylinder

Heat pump with integral or system cylinder

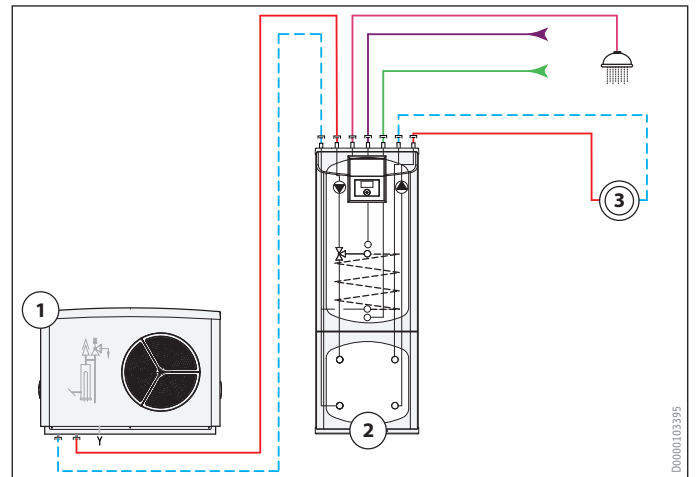

- 1 Heat pump
- 2 Integral cylinder or system cylinder
- 3 Heating circuit

Heat pump principles

Buffer cylinder

Decision to use a buffer cylinder

It is necessary to check whether a buffer cylinder should be used.

Systems without a buffer cylinder are only technically feasible if the following conditions have been met:

- » No buffer cylinder is specified for the installed heat pump.
- » The minimum flow rate of the heat pump is ensured at all times by the installed heat distribution system.
- » The water content in the system is large enough to ensure the minimum runtime of the heat pump.
- » The heat pump supplies just one heating circuit.
- » No blocking times are expected in the power supply or they can be bridged without any significant loss of comfort through the heat distribution system.
- » No incorporation of additional heat generators is planned.

Special features when using a buffer cylinder in the heating system

The additional buffer cylinder volume must be taken into account when sizing the diaphragm expansion vessel.

Hydraulic connection for vibration damping

Connection to the pipework should preferably be flexible, e.g. with pressure hoses. Pressure hoses minimise the transmission of oscillations, vibrations, and other structure-borne sound effects.

Installation without buffer cylinder

If a buffer cylinder is not used, the minimum flow rate of the heat pump must be ensured permanently via the heat distribution system.

The minimum flow rate can, for example, be ensured by means of permanently open heating circuits or overflow devices.

Country-specific regulations concerning individual room control must be observed.

In Germany, individual room control is required. To fulfil this requirement, permanently open heating circuits and the room based remote control must be located in the lead room.

Heat pump principles

Buffer cylinder

Decision to use a buffer cylinder

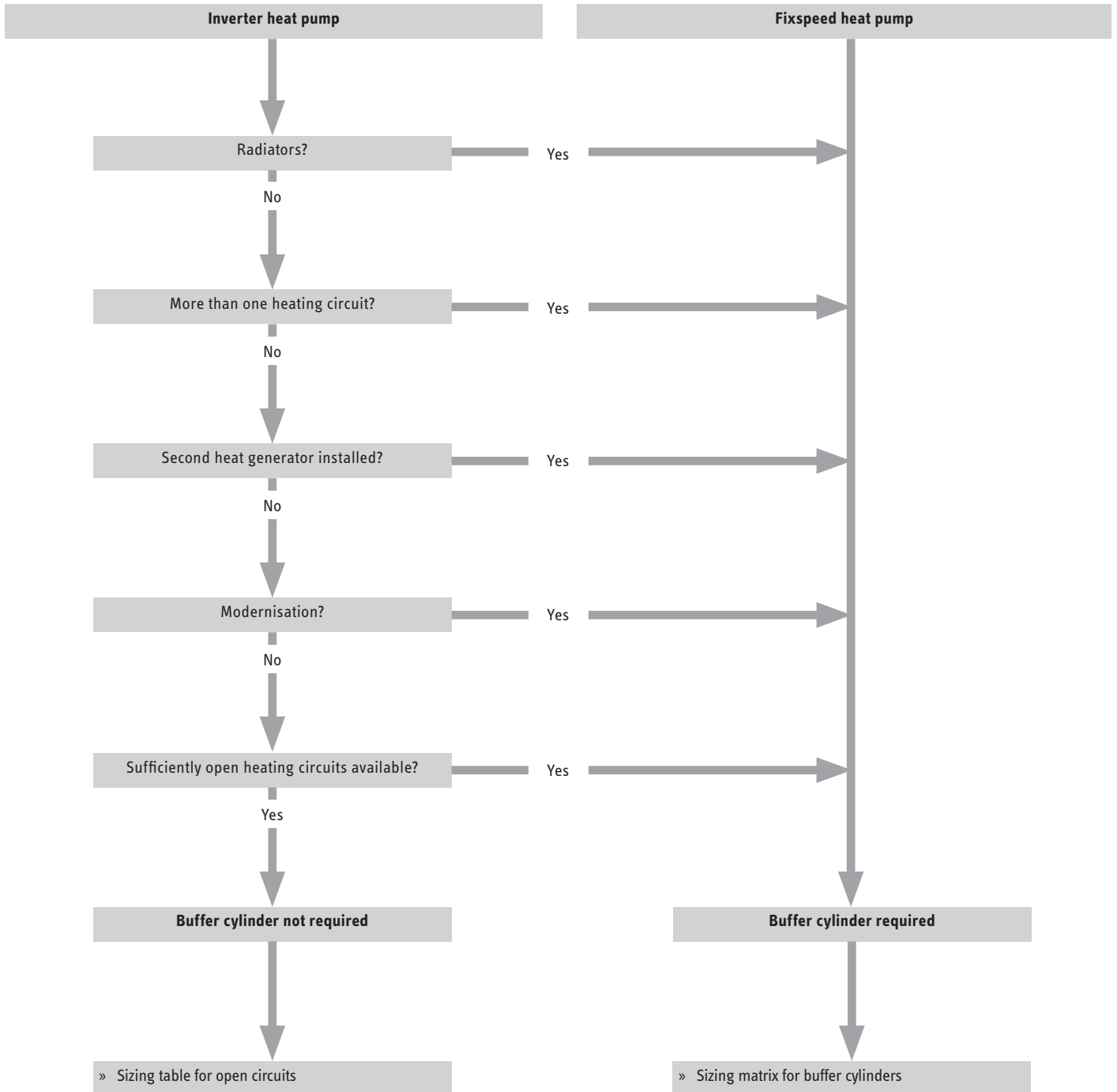

DHW heating

DVGW W 511

Requirements of the DVGW W 551 Code of Practice

The following provides an overview of the requirements to DVGW W 551.

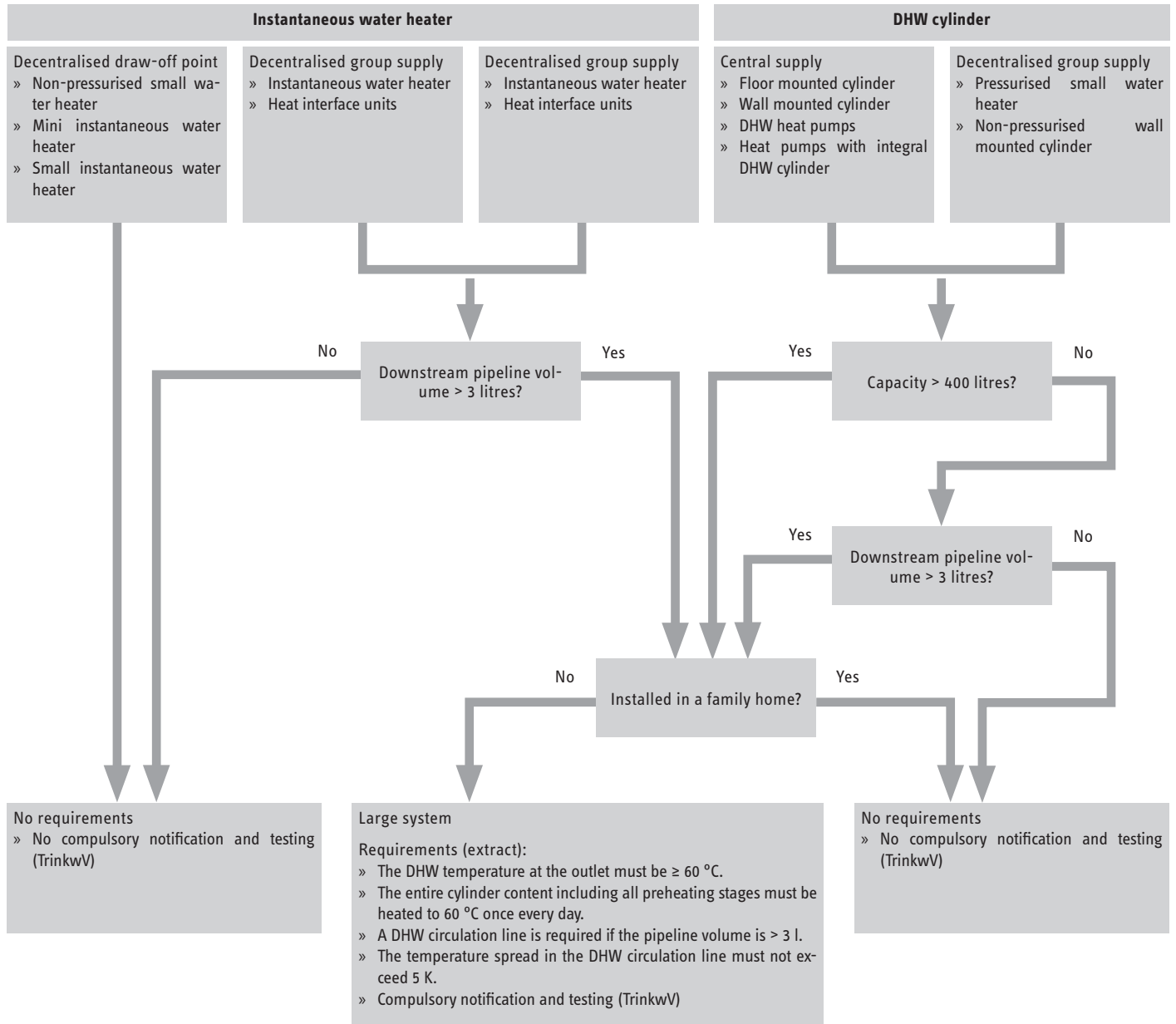

DHW heating

DIN 1988-200

Requirements to DIN 1988-200

The following provides an overview of the requirements to DIN 1988-200.

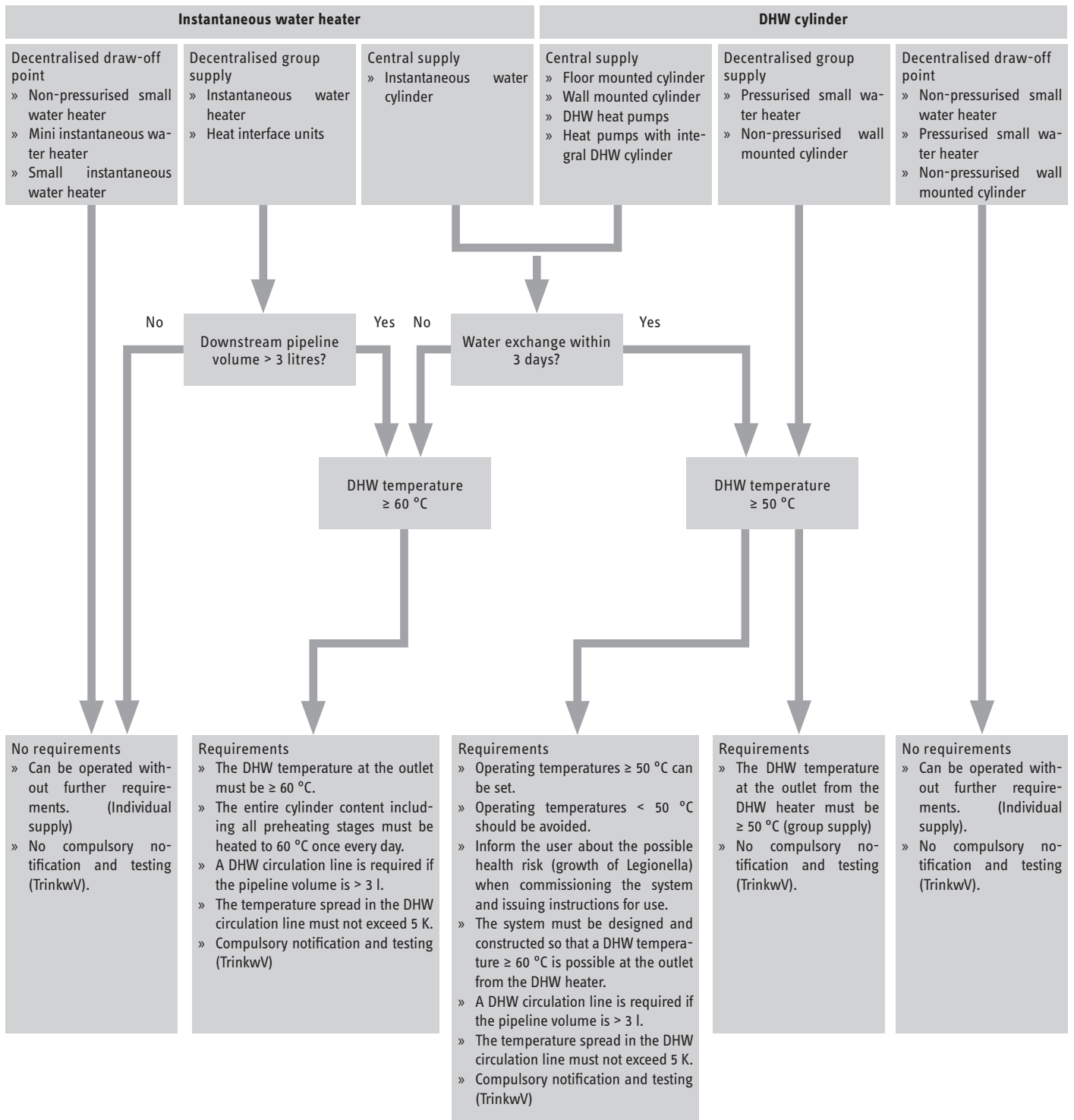

Heat pump principles

Systems for DHW heating

DHW cylinder

The size of the DHW cylinder is subject to the daily and peak consumption, the DHW distribution system and the installed draw-off points.

DHW cylinders for apartment buildings and non-residential buildings are sized in accordance with the consumption profiles and the guidelines pertaining to the hygiene requirements.

DHW is heated via an internal indirect coil or external heat exchanger.

When using an instantaneous water cylinder, DHW is heated by means of an internal indirect coil according to the instantaneous water heating principle.

Internal indirect coil

Efficient DHW heating is carried out via a DHW cylinder with an internal indirect coil.

For transferring large heating outputs, internal indirect coils are only of limited usefulness. This is due primarily to the available surface area of the indirect coil inside the DHW cylinder, as a transfer area of $> 0.25 \text{ m}^2$ is required per kW of heating output.

Subject to the relevant heat pump and the system configuration, DHW temperatures of up to $60 \text{ }^\circ\text{C}$ can be achieved.

Where higher temperatures are required, DHW can be electrically reheated.

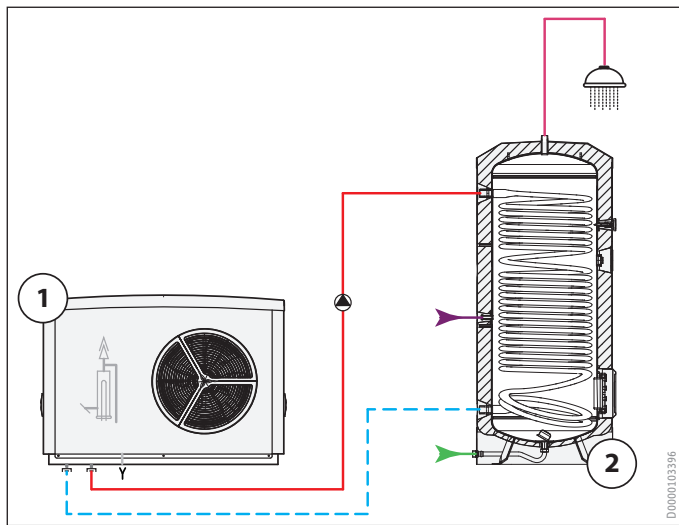

- 1 Heat pump
- 2 DHW cylinder

External heat exchanger

If higher outputs need to be transferred to a DHW cylinder, charging station can be used.

The charging station is sized subject to the output and flow rate of the heat pump. During the design, pressure drops at the plate heat exchanger or the external delivery head of the charging pump must be taken into account.

To achieve the highest possible DHW temperatures, the temperature differential between the primary and secondary sides of the charging station should be as low as possible. Spreads of 2 - 5 K are ideal.

The lower the targeted temperature differential, the greater the surface area of the plate heat exchanger in the charging station.

Ideally, the DHW cylinder is prepared for use with a charging station.

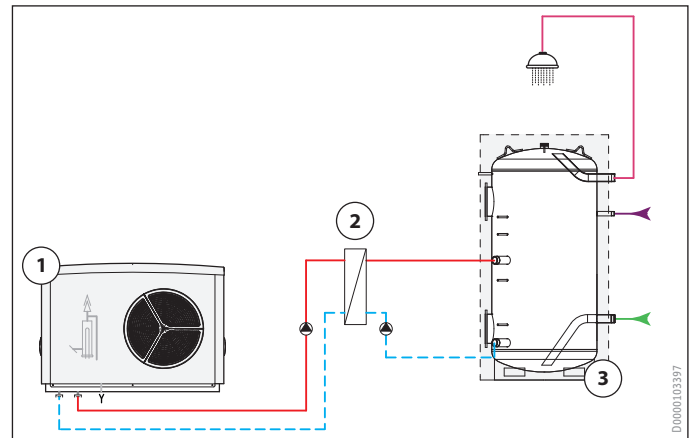

- 1 Heat pump
- 2 Heat exchanger
- 3 DHW cylinder

Heat pump principles

Systems for DHW heating

Instantaneous water cylinder

Instantaneous water cylinders have an internal stainless steel corrugated pipe indirect coil surrounded by heating water.

Only a small quantity of DHW is stored in the indirect coil, ensuring a high rate of water exchange and a high level of DHW hygiene.

At the same time, an instantaneous water cylinder is used as a buffer cylinder for hydraulic separation of the heat pump and heating circuits.

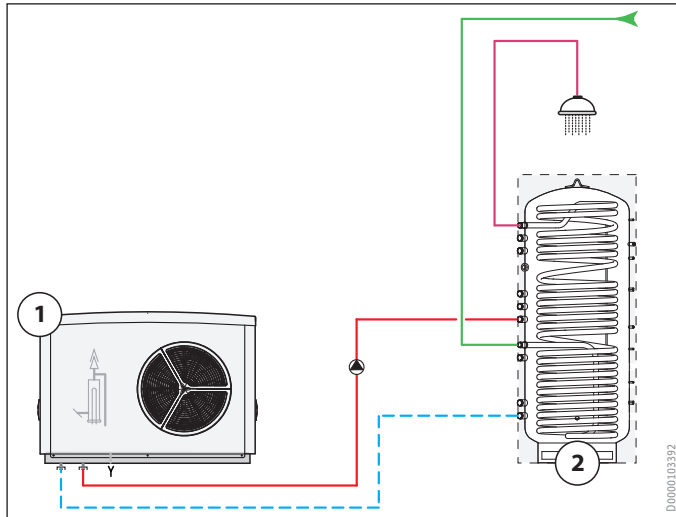

- 1 Heat pump
- 2 Instantaneous water cylinder

Heat pump principles

Systems for DHW heating

Heat interface units

Heat interface units make it possible to combine the benefits of decentralised DHW heating with centralised heat generation.

Heat interface units can be designed as 2-pipe or 4-pipe systems.

2-pipe heat interface unit

2-pipe systems use a shared buffer cylinder, which is operated all year round at a constant system temperature.

A 2-pipe system requires lower investment costs than a 4-pipe system.

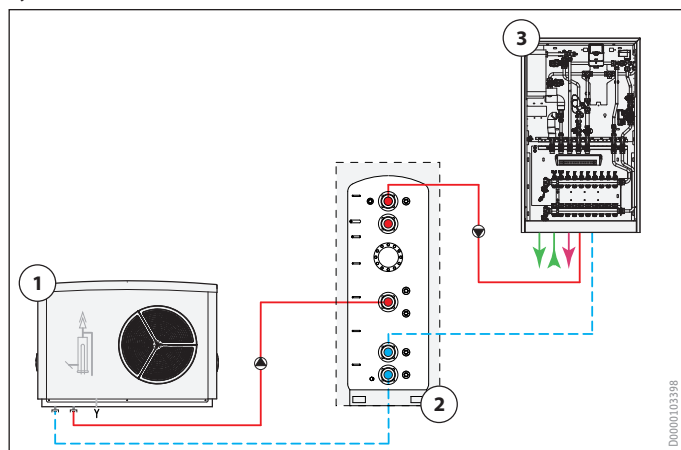

- 1 Heat pump
- 2 Buffer cylinder
- 3 Heat interface unit

4-pipe heat interface unit

The heat interface units in 4-pipe systems are each connected to two flow and return lines.

The heating energy and DHW demand is supplied from buffer cylinders at varying system temperatures.

A 4-pipe system is more efficient than a 2-pipe system.

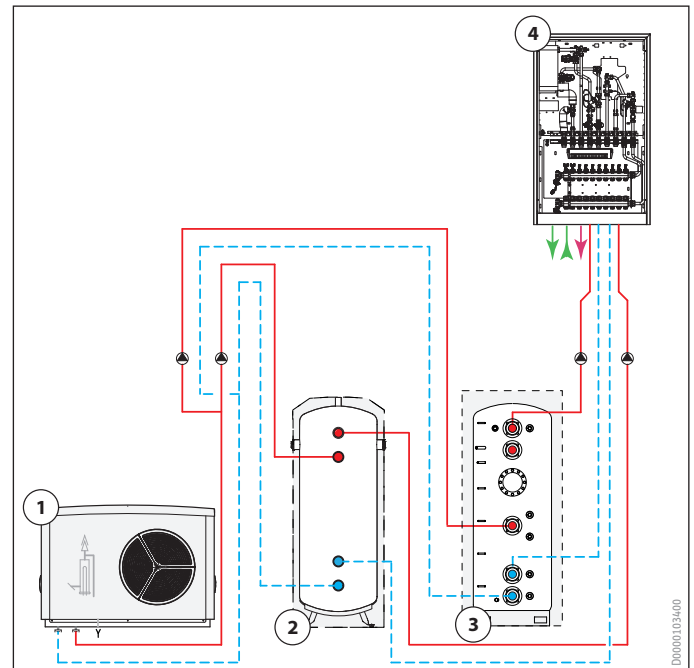

- 1 Heat pump
- 2 Heating buffer cylinder
- 3 DHW buffer cylinder
- 4 Heat interface unit

Notes

Sizing

DHW cylinder

Cylinder sizing for centralised DHW cylinders

The following information does not apply to instantaneous water cylinders and heat interface units. Information from EN 15450 and VDI 4645 is used as reference.

When sizing the centralised DHW cylinder volume, the heat quantities required in the system must be taken into consideration.

Several mutually interacting factors must be considered:

- » The daily demand
- » The peak demand (time limited, maximum demand)
- » Anticipated losses
- » The available heating output for reheating the DHW cylinder

The required DHW output must be available during the reference period either in the form of stored DHW or as heating output.

For sizing, the maximum daily DHW demand and the corresponding consumption pattern must first be determined.

For this calculation, average draw-off profiles can also be used in addition to actual consumption data. Examples of these draw-off profiles for three user groups are given in EN 15450 and can be extended as needed.

From the load profile, the period with the highest output demand is determined.

The output demand is used to determine the cylinder size.

Draw-off types according to EN 15450, Appendix E

Draw-off type	Energy kWh	Volume l	Required value for $\Delta\theta$ K	Draw-off duration at specified mass flow rate in minutes			
				3.5 l/min	5.5 l/min	7.5 l/min	9.0 l/min
Light	0.105	3	30	0.9	0.5	0.4	0.3
Floor	0.105	3	30	0.9	0.5	0.4	0.3
Cleaning	0.105	2	45	0.6	0.4	0.3	0.2
Dishwashing, light	0.315	6	45	1.7	1.1	0.8	0.7
Dishwashing, moderate	0.420	8	45	2.3	1.5	1.1	0.9
Dishwashing, intense	0.735	14	45	4.0	2.5	1.9	1.6
"Max"	0.525	15	30	4.3	2.7	2.0	1.7
Shower	1,400	40	30	11.4	7.3	5.3	4.4
Bath	3,605	103	30	29.4	18.7	13.7	11.4

Sizing

EN 15450 in apartment buildings/draw-off profile table

EN 15450 in apartment buildings

EN 15450 gives examples of three different draw-off profiles:

1. Average draw-off profile of an individual person (36 l at 60 °C)
2. Average draw-off profile of a family, including showers (100 l at 60 °C)
3. Average draw-off profile of a family of three including baths and showers (200 l at 60 °C)

Draw-off profile table "3"

This table gives the average draw-off profile of a family of three.

The values and totals form the basis for the subsequent sizing example.

No.	Time of day hh:mm	Draw-off type	Energy, draw-off process kWh	Reference period for partial heating systems		Required value for $\Delta\vartheta$ (must be reached during draw-off) K	Minimum value of ϑ for starting the energy use meter °C
				Daily demand	Peak demand		
1	07:00	Light	0.105				25
2	07:05	Shower	1,400	x			40
3	07:30	Light	0.105	x			25
4	07:45	Light	0.105	x	x		25
5	08:05	Bath	3,605	x	x	30	10
6	08:25	Light	0.105	x	x		25
7	08:30	Light	0.105	x	x		25
8	08:45	Light	0.105	x	x		25
9	09:00	Light	0.105	x			25
10	09:30	Light	0.105	x			25
11	10:30	Floor	0.105	x		30	10
12	11:30	Light	0.105	x			25
13	11:45	Light	0.105	x			25
14	12:45	Dishwashing	0.315	x		45	10
15	14:30	Light	0.105	x			25
16	15:30	Light	0.105	x			25
17	16:30	Light	0.105	x			25
18	18:00	Light	0.105	x			25
19	18:15	Clean	0.105	x			40
20	18:30	Clean	0.105	x			40
21	19:00	Light	0.105	x			25
22	20:30	Dishwashing	0.735	x	x	45	10
23	21:00	Bath	3,605	x	x	30	10
24	21:30	Light	0.105		x		25

Summary

Q_{DP}	kWh	11,655	11,445	4,445
T_{DP}	hh:mm	14:30	13:55	1:00

Q_{DP} Energy demand for DHW heating during the selected reference period in kWh

T_{DP} Period before the selected (most adverse) reference period available for reheating the cylinder volume

Sizing example "Apartment building with centralised DHW cylinder"

The example is based on an apartment building with 10 identical residential units.

Each apartment has standard bathroom facilities with shower.

DHW heating is carried out centrally by means of a heat pump and a DHW cylinder with an internal indirect coil.

The DHW cylinder is sized based on the reference period with the highest DHW demand in one day (Q_{DPB}).

The heat pump is sized based on the total DHW demand in one day (Q_{DP}).

Energy demand during one reference period

For sizing DHW heating, the reference period with the highest energy demand is taken from the draw-off profile table. This reference period is the time from 20:30 to 21:30 h. Energy demand is 2,240 kWh per apartment.

The total energy demand for the reference period is determined with the following formula:

$$Q_{DPB} = n_{NE} \cdot Q_{DPB,NNE}$$

Q_{DPB}	Energy demand during a reference period in kWh
$Q_{DPB,NNE}$	Energy demand for a residential unit during a reference period in kWh
n_{NE}	Number of residential units with the same profile

The sizing example gives an energy demand during the reference period of:

$$Q_{DPB} = 10 \cdot 2,240 \text{ kWh} = 22,40 \text{ kWh}$$

Amount of DHW during one reference period

From the total energy demand during a reference period, the required amount of DHW is calculated.

$$V_{DPB} = \frac{Q_{DPB}}{c_W \cdot (\vartheta_{soll} - \vartheta_{KW})}$$

V_{DPB}	Required amount of DHW during a reference period in l
Q_{DPB}	Energy demand during the selected reference period in kWh
c_W	Specific thermal capacity (when water = 1,163 Wh/(kg·K))
ϑ_{soll}	Set cylinder temperature in °C.
ϑ_{KW}	Cold water temperature in °C (in Germany 10 °C)

$$V_{DPB} = \frac{22,40 \text{ kWh}}{1,163 \frac{\text{Wh}}{\text{kg} \cdot \text{K}} \cdot (60^\circ\text{C} - 10^\circ\text{C})} = 385 \text{ l}$$

The required amount of DHW during the reference period is 385 l.

Losses

When selecting the DHW cylinder, the following losses must be taken into account:

- » DHW circulation losses
- » Standby losses in the DHW cylinder
- » Mixing and heat transfer losses

DHW circulation losses are calculated during the design. Experience shows that DHW circulation losses may be between 30 and 40 % of the DHW demand. In this example, DHW circulation losses are assumed to be 35 % or 0.86 kWh per hour.

$$Q_{Zirk} = \frac{Q_{DP} \cdot 0,35}{24 \text{ h}} = \frac{58,45 \text{ kWh} \cdot 0,35}{24 \text{ h}} \cong 0,86 \frac{\text{kWh}}{\text{h}}$$

To cover the DHW circulation losses, an additional cylinder volume is required:

$$V_{Zirk} = \frac{Q_{Zirk}}{c_W \cdot (\vartheta_{soll} - \vartheta_{Zirk,RL})}$$

V_{Zirk}	Required amount of DHW to offset the DHW circulation losses
Q_{Zirk}	DHW circulation losses in kWh/h
c_W	Specific thermal capacity (when water = 1,163 Wh/(kg·K))
ϑ_{soll}	Set cylinder temperature in °C.
ϑ_{KW}	Return temperature of the DHW circulation line in °C

$$V_{Zirk} = \frac{0,86 \frac{\text{kWh}}{\text{h}}}{1,163 \frac{\text{Wh}}{\text{kg} \cdot \text{K}} \cdot (60^\circ\text{C} - 55^\circ\text{C})} = 148 \text{ l}$$

Sizing

Apartment building with centralised DHW cylinder

15 % of the cylinder volume is assumed to be a supplement compensating for the cylinder volume that cannot be used.

The total cylinder volume required is calculated using the following formula:

$$V_{SP,min} = (V_{DPB} + V_{Zirk}) \cdot f_{TWE}$$

$V_{SP,min}$	Cylinder volume in l
V_{DPB}	Required amount of DHW during the selected reference period in l
V_{Zirk}	Required amount of DHW to offset the DHW circulation losses
f_{TWE}	Supplement to compensate for mixing losses ($f_{TWE}=1.15$)

$$V_{SP,min} = (385 \text{ l} + 148 \text{ l}) \cdot 1,15 = 613 \text{ l}$$

The DHW cylinder must have a nominal capacity of >613 l.

Heat pump output for combined heating and DHW

If the heat pump is not used exclusively for DHW heating, then heating and cooling operation, as well as other uses, must be taken into consideration.

Heat pump output for DHW heating

The heat pump output for DHW heating alone must be selected so that the entire content of the DHW cylinder is heated within the required heat-up time.

When determining the heat-up time, the demand peaks and particularly suitable times for heating the DHW cylinder must be taken into consideration. If a photovoltaic system is incorporated, the daylight hours, for example, must be taken into consideration.

The required heat pump output is determined as follows:

$$\dot{Q}_{WP,min} = \frac{V_{Sp} \cdot c_W \cdot (\vartheta_{soll} - \vartheta_{KW})}{t_{AD}}$$

$\dot{Q}_{WP,min}$	Required heat pump output in kW
c_W	Specific thermal capacity (when water = 1,163 Wh/(kg·K))
ϑ_{soll}	Set cylinder temperature in °C.
ϑ_{KW}	Cold water temperature in °C (in Germany 10 °C)
t_{AD}	Heat-up time in h

The period between the two peak demands is available for heating the DHW cylinder (07:00 to 07:30 h and 20:30 to 21:30 h). The heat-up period is 13 hours.

$$\dot{Q}_{WP,min} = \frac{613 \text{ l} \cdot 1,163 \frac{\text{Wh}}{\text{kg} \cdot \text{K}} \cdot (60^\circ\text{C} - 10^\circ\text{C})}{13 \text{ h}} \cong 2,7 \text{ kW}$$

The heat pump must have a heating output of >2.7 kW.

If additional heat demands need to be covered, the relevant heat quantities must be taken into consideration when the heating output is calculated.

Sizing table "Centralised DHW cylinder for residential buildings"

Draw-off profile table "3" is used as a guide for volumes for centralised DHW cylinders in apartment buildings with a selected consumption profile for 3 persons with a shower. Draw-off profile table "3" is no substitute for project-specific DHW heating design.

The sizing of the DHW cylinder in draw-off profile table "3" shown is based on the calculation regulations of EN 15450. The calculation is carried out using the heat quantities (given in draw-off profile table "3") that are required for an average DHW demand of a family comprising 3 persons with shower:

- » 5,845 kWh daily demand per apartment
- » 2.24 kWh peak demand per apartment

The cylinder volume is calculated subject to the number of residential units. Mixing and DHW circulation losses are taken into account as general flat-rate values according to the calculation example.



x Residential units
y Cylinder volume
1 Curve

Simplified procedure for family homes

In family homes with standard bathroom facilities, the required cylinder size and heating output can be calculated using a simplified method.

A daily average DHW demand of 1.45 kWh per person is assumed. The value corresponds to a DHW volume of 25 l at 60 °C. To approximately account for the cylinder and distribution losses, the value is doubled. This is then converted to the actual storage temperature. The storage temperature in family homes is usually 50 °C.

$$V_{SP,min} = 2 \cdot n \cdot V_{DP,60} \cdot \frac{\vartheta_{Ref} - \vartheta_{KW}}{\vartheta_{soll} - \vartheta_{KW}}$$

$V_{SP,min}$ Minimum cylinder volume in litres
n Number of occupants
 $V_{DP,60}$ Daily DHW demand per person at 60 °C in litres
 ϑ_{Ref} Reference cylinder temperature in °C (60 °C)
 ϑ_{soll} Set cylinder temperature in °C.
 ϑ_{KW} Cold water temperature in °C

$$V_{SP,min} = 2 \cdot 3 \cdot 25 \text{ l} \cdot \frac{60 \text{ °C} - 10 \text{ °C}}{50 \text{ °C} - 10 \text{ °C}} = 187,5 \text{ l}$$

For 1 to 3 persons, a DHW cylinder with a nominal capacity of up to 200 l is selected.

For 4 to 5 persons, a DHW cylinder with a nominal capacity of up to 300 l is selected.

Sizing

Instantaneous water cylinder for residential buildings

Sizing table for instantaneous water cylinders in residential buildings

Instantaneous water cylinders are sized based on draw-off profiles in conjunction with the corresponding instantaneous water cylinder.

Subject to the charging temperature of the instantaneous water cylinder and installed heat generator output, a suitable instantaneous water cylinder can be selected from the type-specific sizing table.

During sizing, the maximum flow rate of the instantaneous water cylinder and the pressure drops at the heat exchanger must be taken into consideration.

Sizing

Cylinder sizing for heat interface units

Cylinder sizing for heat interface units

Cylinder sizing for heat interface units is based on the connected load of the heat interface unit and the simultaneity in DHW heating.

Subject to the type of heat interface unit, the heat load must also be taken into account when calculating the cylinder size.

For 2-pipe systems, the DHW heating output and the heating output are added together.

For 4-pipe systems, the DHW cylinder and the heating water buffer cylinder must be considered separately.

Sizing example for "Apartment building with heat interface units"

The example is based on an apartment building with 12 identical residential units.

Each apartment has standard bathroom facilities with shower.

DHW heating is carried out decentrally by means of heat interface units supplied via a 2-pipe system.

The simultaneity in DHW demand is required to determine the cylinder size.

$$\varphi = n^{(-0,57)} = 12^{-0,57} = 0,2426$$

φ DHW heating simultaneity factor
 n Number of residential units+

The simultaneity factor determines the number of heat interface units that can be utilised simultaneously for DHW heating.

$$n_{NE,TWW} = n \cdot \varphi = 12 \cdot 0,2426 = 2,91 \approx 3$$

$n_{NE,TWW}$ Heat interface units that can be utilised simultaneously for DHW heating
 n Number of installed heat interface units
 φ Simultaneity factor

The following applies to heat interface units that can be utilised simultaneously for heating mode:

$$n_{NE,Hzg} = n - n_{NE,TWW} = 12 - 3 = 9$$

$n_{NE,Hzg}$ Heat interface units that can be utilised simultaneously for heating mode
 n Number of installed heat interface units
 $n_{NE,TWW}$ Heat interface units that can be utilised simultaneously for DHW heating

Simultaneity factors

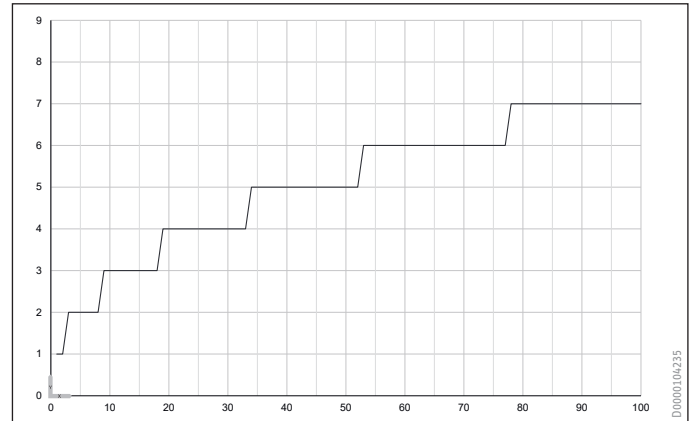

x Heat interface units that can be utilised simultaneously
 y Number of heat interface units
 1 Installed heat interface units

The following formula calculates the required buffer cylinder volume for heating operation.

$$V_{Sp,Hzg} = \frac{Q_H \cdot n_{NE,Hzg} \cdot t_{20min}}{c_W \cdot (\vartheta_{VL} - \vartheta_{RL})}$$

$V_{Sp,Hzg}$ Required buffer cylinder volume for heating operation
 Q_H Heat load per apartment
 $n_{NE,Hzg}$ Heat interface units that can be utilised simultaneously for heating mode
 t_{20min} 20 minute reference period
 c_W Specific thermal capacity (when water = 1,163 Wh/(kg·K))
 ϑ_{VL} Set cylinder temperature
 ϑ_{RL} Return temperature of the heat interface unit

The 12 residential units are equipped with heat interface units in a 2-pipe system.

The 12 apartments each with a heat load of 3 kW are supplied via an underfloor heating system.

$$V_{Sp,Hzg} = \frac{3 \text{ kW} \cdot 9 \cdot 0,33}{1,163 \frac{\text{Wh}}{\text{kg} \cdot \text{K}} \cdot (55 \text{ °C} - 28 \text{ °C})} = 284 \text{ l}$$

Sizing

Cylinder sizing for heat interface units

The required cylinder volume for DHW heating is:

$$V_{Sp,TWW} = \frac{(n_{NE,TWW} \cdot P_{WST} \cdot t_{20min} + Q_{BV}) \cdot f_{TWE}}{c_w \cdot (\vartheta_{VL} - \vartheta_{RL})}$$

$V_{Sp,TWW}$	Required buffer cylinder volume for DHW heating
$n_{NE,TWW}$	Heat interface units that can be utilised simultaneously for DHW heating
P_{WST}	Heat interface unit output on the primary side
t_{20min}	20 minute reference period
Q_{BV}	Standby heat loss in kWh
f_{TWE}	Supplement to compensate for heat transfer and mixing losses ($f_{TWE}=1.20$)
c_w	Specific thermal capacity (when water = 1,163 Wh/(kg·K))
ϑ_{VL}	Set cylinder temperature
ϑ_{RL}	Return temperature of the heat interface unit

For DHW heating, a draw-off rate of 13 l/min at 50 °C must be available.

The heat interface unit connected load on the primary side is 36.2 kW.

$$V_{Sp,TWW} = \frac{(3 \cdot 36,2 \text{ kW} \cdot 0,33 + 2,20 \text{ kWh}) \cdot 1,20}{1,163 \frac{\text{Wh}}{\text{kg} \cdot \text{K}} \cdot (55 \text{ °C} - 20,8 \text{ °C})} = 1.148 \text{ l}$$

Cylinder volume in the 2-pipe system

In a 2-pipe system, the cylinder volumes $V_{Sp,Hzg}$ and $V_{Sp,TWW}$ are added to the minimum volume of the buffer cylinder to be used.

$$V_{Sp,2L} = V_{Sp,Hzg} + V_{Sp,TWW} = 284 \text{ l} + 1.148 \text{ l} = 1.432 \text{ l}$$

The buffer cylinder must have a volume of >1432 l.

Cylinder volume in the 4-pipe system

In a 4-pipe system, two buffer cylinders are used.

The minimum volume for the heating water buffer cylinder is 284 litres.

The minimum volume for the buffer cylinder for DHW heating is 1148 l.

Heat pump heating output

The required size of the heat pump is calculated on the basis of the daily amounts of energy required for heating and DHW heating.

Sizing example for "Apartment building with centralised DHW heating"

The example is based on an apartment building with 10 residential units and a heat load of 20 kW.

The cooling load for temperate heating of the building in summer via the underfloor heating system is 15 kW.

Each apartment has standard bathroom facilities with shower.

DHW heating is carried out centrally by means of an air source heat pump and a DHW cylinder with an internal indirect coil.

Heat pump heating output

To determine the required heat pump output, in addition to the energy demand for room heating and cooling, the energy demand for DHW heating and other uses, e.g. swimming pool, is also taken into consideration.

The daily DHW demand Q_{DP} can be found in draw-off profile table "3".

$$Q_{DP} = n_{NE} \cdot Q_{DP,NNE} = 10 \cdot 5,845 \text{ kWh} = 58,45 \text{ kWh}$$

Q_{DP}	Daily energy demand for DHW in kWh
$Q_{DP,NNE}$	Daily energy demand of a residential unit for DHW in kWh
n_{NE}	Number of residential units with the same profile

To determine the total energy demand for DHW heating, the DHW circulation losses and standby heat losses must also be taken into account.

DHW circulation losses must be calculated during the design and, in this example, are 20.00 kWh/day.

Here, the standby heat losses of the DHW cylinder used are 3.50 kWh/day.

$$Q_{DP,ges} = Q_{DP} + Q_{Zirk} + Q_{BV} = 58,45 \text{ kWh} + 20,00 \text{ kWh} + 3,50 \text{ kWh} = 81,95 \text{ kWh}$$

$Q_{DP,ges}$	Daily amount of energy for DHW heating incl. losses in kWh
Q_{DP}	Daily energy demand for DHW in kWh
Q_{Zirk}	Daily amount of energy to cover DHW circulation losses in kWh
Q_{BV}	Daily amount of energy to cover standby heat losses in kWh

The heat pump output is designed so that the maximum energy demand within a day at standard outside temperature is met by the heat pump.

Any possible blocking times by the power supply utility are taken into consideration.

$$Q_{WP,erf} = \frac{Q_{H,AP} + Q_{DP,ges} + Q_{sonst}}{d - \sum t_{SD}}$$

$Q_{WP,erf}$	Required heat pump output in kW
$Q_{H,AP}$	Daily amount of energy for DHW heating incl. losses in kWh
$Q_{DP,ges}$	Daily amount of energy to cover DHW circulation losses in kWh
Q_{sonst}	Daily amount of energy to cover standby heat losses in kWh
$\sum t_{SD}$	Daily total of blocking times by the power supply utility

The heat load $Q_{H,AP}$ is 20 kW.

No other uses exist.

The blocking time by the power supply utility is 4 hours daily.

The required heat pump output is:

$$Q_{WP,erf} = \frac{24 \text{ h} \cdot 20 \text{ kW} + 81,95 \text{ kWh} + 0 \text{ kWh}}{24 \text{ h} - 4 \text{ h}} = 28,1 \text{ kW}$$

An air source heat pump is selected with a rated heating output of 25.7 kW at A-7/W35. This means that mono energetic operation is possible.

The output differential of 2.4 kW is covered by a second heat generator, e.g. electrically.

In active cooling mode, the heat pump has a capacity of 34.1 kW at A35/W18.

The heat pump covers the required cooling load of 15 kW to ensure temperate heating in summer via the floor area.

Sizing

Apartment building with centralised DHW heating

Plausibility check

Once the heat pump has been sized, a plausibility check is recommended.

This is based on the draw-off profiles in draw-off profile table "3" used for DHW heating engineering.

The output of the selected heat pump must be large enough to charge the DHW cylinder prior to the unfavourable reference period.

$$\frac{Q_{DPB}}{\dot{Q}_{WP, gewählt} \cdot t_{DPB}} \leq 1$$

Q_{DPB} Energy demand during a reference period in kWh

$\dot{Q}_{WP, gewählt}$ Output of the selected heat pump in kW

t_{DPB} Period prior to the selected reference period, which is available for reheating the cylinder volume.

The reference period used is between 20:30 and 21:30 h with an energy demand of 22.4 kWh.

For prior heat-up, the period from 19:00 to 20:30 h (1.5 hours) is available without DHW demand.

$$\frac{22,4 \text{ kWh}}{25,7 \text{ kW} \cdot 1,50 \text{ h}} = 0,58 \leq 1$$

The heat pump must be large enough to cover the heat demand of the building and charge the DHW cylinder prior to the unfavourable reference period.

Sizing example for "Apartment building with heat interface unit"

The example is based on an apartment building with 12 residential units and a heat load of 2.5 kW per apartment.

Each apartment has standard bathroom facilities with shower.

Heating and DHW heating are carried out via heat interface units in a 2-pipe system.

A ground source heat pump is used as the central heat generator.

Heat pump heating output

To determine the required heat pump output, in addition to the energy demand for room heating, the energy demand for DHW heating and other uses, e.g. swimming pool, should also be taken into consideration.

The daily DHW demand can be found in draw-off profile table "3" and is:

$$Q_{DP} = n_{NE} \cdot Q_{DP,NNE} = 12 \cdot 5,845 \text{ kWh} = 70,14 \text{ kWh}$$

Q_{DP}	Daily energy demand for DHW in kWh
$Q_{DP,NNE}$	Daily energy demand of a residential unit for DHW in kWh
n_{NE}	Number of residential units with the same profile

To determine the total energy demand for DHW heating, the line losses for the heat interface unit and the standby heat losses in the DHW cylinder must also be taken into account.

Line losses must be calculated during the design and, in this example, are 12.00 kWh/day.

Here, the standby heat losses are 4.10 kWh/day.

$$Q_{DP,ges} = Q_{DP} + Q_{Zirk} + Q_{BV} = 70,14 \text{ kWh} + 12,00 \text{ kWh} + 4,10 \text{ kWh} = 86,24 \text{ kWh}$$

$Q_{DP,ges}$	Daily amount of energy for DHW heating incl. losses in kWh
Q_{DP}	Daily energy demand for DHW in kWh
Q_{Zirk}	Daily amount of energy to cover DHW circulation losses in kWh
Q_{BV}	Daily amount of energy to cover standby heat losses in kWh

The heat pump output is designed so that the maximum energy demand within a day at standard outside temperature is met by the heat pump.

Any possible blocking times by the power supply utility are taken into consideration.

$$Q_{WP,erf} = \frac{Q_{H,AP} + Q_{DP,ges} + Q_{sonst}}{d - \sum t_{SD}}$$

$Q_{WP,erf}$	Required heat pump output in kW
$Q_{H,AP}$	Daily amount of energy for DHW heating incl. losses in kWh
$Q_{DP,ges}$	Daily amount of energy to cover DHW circulation losses in kWh
Q_{sonst}	Daily amount of energy to cover standby heat losses in kWh
$\sum t_{SD}$	Daily total of blocking times by the power supply utility

The heat load $Q_{H,AP}$ is 30 kW.

No other uses exist.

The blocking time by the power supply utility is 4 hours daily.

This gives a required heat pump output of:

$$Q_{WP,erf} = \frac{24 \text{ h} \cdot 30 \text{ kW} + 86,24 \text{ kWh} + 0 \text{ kWh}}{24 \text{ h} - 4 \text{ h}} = 40,3 \text{ kW}$$

A ground source heat pump is selected with a rated heating output of 42.0 kW at B0/W55.

This means that mono mode operation is possible.

Notes

Cooling

Passive and active cooling

Passive cooling

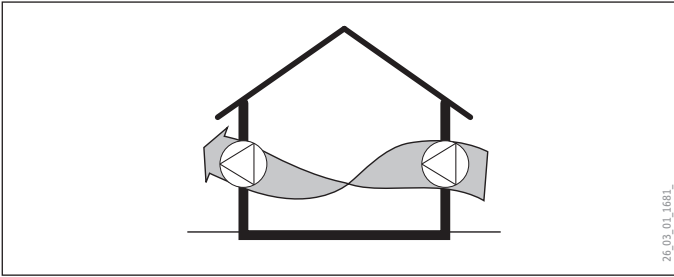

- » Utilisation of natural cooling sinks
- » Cool ground / cool night air
- » Utilisation of storage effects

The low temperature of the groundwater or soil is transferred to the heating system via a heat exchanger.

The heat pump compressor is not started. The heat pump remains "passive".

Active cooling

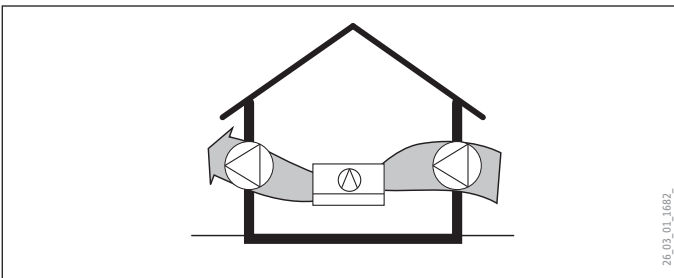

- » Utilisation of refrigerators

The cooling capacity of the heat pump (cold side) is transferred to the heating system.

The heat pump compressor is started. The heat pump is "active".

Procedure for engineering passive cooling

- » Calculating the cooling load
- » to VDI 2078
- » in accordance with a standard form
- » According to m² living space (factor)
- » Determining the cooling capacity of the heat source
- » Geothermal probe
- » Groundwater
- » Design of the distribution system
- » Underfloor heating
- » Fan convectors

Design information

The cooling capacity of the heat source is sized according to the cooling capacity of the heat pump.

Example: Two geothermal probes with a depth of 94 m provide a heat transfer of approx. 7.2 kW to the soil.

The heat absorption capability of the heat source must be greater than the building's cooling load (heat emission). If the cooling load is greater, the required room temperature is not reached.

To achieve the required room temperature, some rooms may have to be excluded from the cooling.

Temperature curve underground

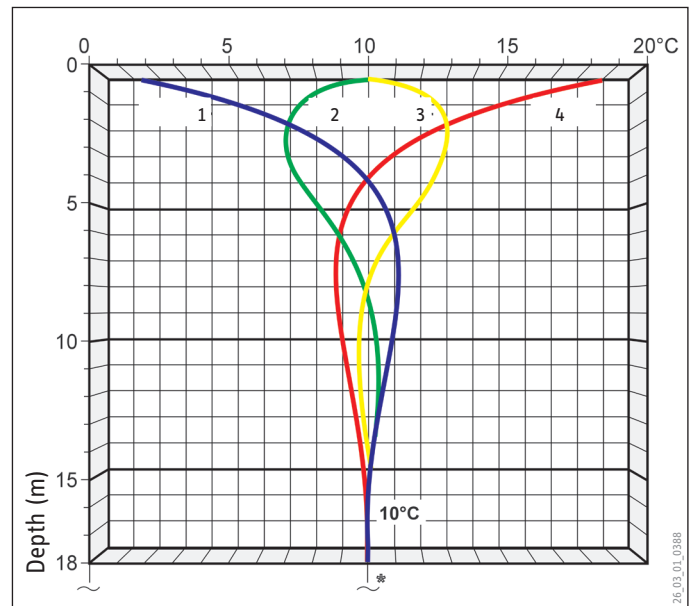

+1 °C temperature rise every 33 m

- 1 February
- 2 May
- 3 November
- 4 August

Average temperatures underground [°C]

Drilling depth m	Exposed site	Urban area	High location
0	9.5	9.5	3.2
25	11.3	12.5	8.0
50	12.0	13.5	8.7
75	12.8	14.5	9.5
100	13.5	15.5	10.2
125	14.3	16.5	11.0
150	15.0	17.5	11.7
175	15.8	18.5	12.5
200	16.5	19.5	13.2

Cooling

Cooling load calculation

Cooling load calculation

The cooling load is calculated in accordance with VDI 2078.

The cooling load calculation sheet or calculator program on our website can help make it easier to calculate the cooling load of a room.

Simplified cooling load calculation with the calculation sheet

The cooling load calculation form enables a quick and easy calculation of the cooling load of a room.

Sizing basis: Outdoor air temperature +32 °C at a room temperature of +27 °C and constant operation.

Position 1

Window areas must be grouped according to the different directions they face and multiplied by the relevant values. For the sum during cooling load calculation, the direction resulting in the highest value should be used. If windows face two directly adjacent directions, e.g. south and south west, the sum of both values must be used. Horizontal skylights must also be taken into consideration. In the case of sun protection devices, the specified values should be taken into consideration.

Position 2

For walls, flat-rate values were used in accordance with VDI 2078. In the case of solid construction in particular, the cooling load is not significantly affected by walls.

Position 3

Floors below unheated cellars or areas bordering the ground are not taken into account.

Position 4

The ceiling area minus any skylights must be multiplied by the relevant value.

Position 5

The heat given off by electrical equipment and lighting is taken into consideration in line with their connected load and is multiplied by a factor of 0.75.

These appliances must only be taken into consideration if they are on during cooling operation.

Position 6

The number of persons must be multiplied by the specified value. According to VDI 2078, heat emitted is based on an assumption of no physical activity through to light work.

Position 7

Here, the outdoor air proportion of the appliance must be used in accordance with the information from the manufacturer. The cooling down of the outdoor air proportion is taken into account at 5 K.

Cooling load

Total of the individual cooling loads for positions 1 to 7.

Appliance sizing

To achieve a room temperature of approx. 5 K below the outside temperature, the appliance cooling capacity must be equal to or greater than the calculated cooling load.

Basics

Apart from the influences stated above, this calculation process also takes into account the storage capacity of the room. This is based on the variables in VDI 2078.

Example calculation using the cooling load calculation sheet

The example calculation on the cooling load calculation sheet was carried out with the following data:

Room size 5.0 m wide, 5.0 m long, 3.0 m high

Window size 4.0 m² facing west

Sun protection on outside

Number of occupants: 2

Computer 150 W connected load

Printer 50 W connected load

Flat roof, insulated

External walls of light construction

Result

The calculated cooling capacity of room 1 is 2.5 kW.

Cooling

Cooling load calculation form

System location

Town

1. Insolation through windows and external doors

	Solar protection			Window area m ²	Cooling load W
	without	inside	outside		
North	0	0	0		
North-east	115	40	25		
East	240	120	50		
South-east	200	105	20		
South	220	145	45		
South-west	330	160	45		
West	320	180	100	4.0	400
North west	220	130	80		
Attic window	320	180	100		
Total					400

2. Walls minus window and door openings that have already been taken into account

	Cooling load W/m ²	Wall area m ²	Cooling load W
External walls	10	26.0	
Internal walls	10	15.0	
Total			410

3. Flooring for non-air conditioned room

	Cooling load W/m ²	Floor area m ²	Cooling load W
Total	10	25.0	250

4. Ceiling less roof windows and fanlights that have already been recorded

	Flat roof		Pitched roof		Ceiling to- wards non-air conditioned areas W/m ²	Ceiling area m ²	Cooling load W
	not insulated	insulated	not insulated	insulated			
	W/m ²	W/m ²	W/m ²	W/m ²			
Total	30	18	50	25	10	25.0	450

5. Electrical appliances that operate at the time of cooling

	Connected load W	Quantity Pce	Operating time h x factor	Cooling load W	
Fluorescent light 20 W/m ²			25.0	0.75	375
Bulb 80 W/m ²				0.75	
Computer, 150 W/pce		2		1.0	300
Printer, 50 W/pce				0.75	
Machinery				1.0	
Computer centre and server rooms				1.0	
Total					675

6. Heat emitted by occupants who are at rest or performing only light work

	Cooling load/ person	Number of persons	Cooling load W
Activity I	100		
Activity II	125	2	250
Activity III	170		
Activity IV	210		
Total			250

Cooling

Cooling load calculation form

7. Outdoor air for air conditioning units with proportion of outdoor air

	Cooling load	Air flow rate	Cooling Load
	W/m ²	m ²	W
Total	10		

Total cooling load of the room in watts

2435

Key

Activity I Seated and relaxing

Activity II Seated activity; office, school, lab

Activity III Standing, light activity; retail, labs, light industry

Activity IV Standing, moderate activity; lab assistants, machine operators

- » The cooling load calculation estimates a temperature reduction of approx. 5 °C
- » The determined results are used for a simplified and approximate cooling load calculation. The values must be checked by an engineer.
- » The calculation sheet complies with VDI 2078/VDI 6007.

Cooling

Heat sinks for cooling operation

Comfort zone (Leusden & Freymark)

Our mental capacities suffer severely at room temperatures that are too low or too high. Comfortable room temperatures are therefore essential to our wellbeing.

In most cases, cooling systems can ensure very good room comfort with only little energy expenditure. The energy exchange between a person and the cooling area predominantly takes the form of radiation.

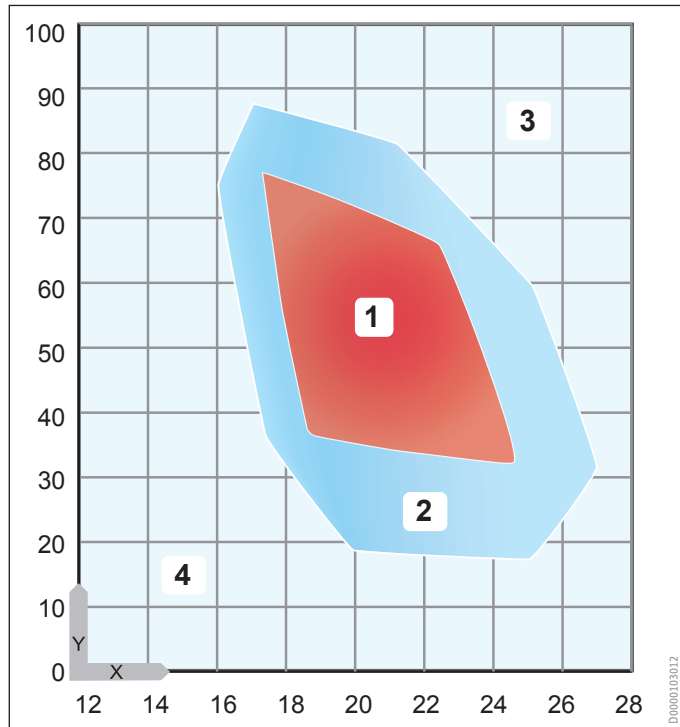

- x Room temperature T_L in °C
- y Relative humidity in %
- 1 Comfortable
- 2 Just comfortable
- 3 Uncomfortably humid
- 4 Uncomfortably dry

Cooling with a geothermal probe

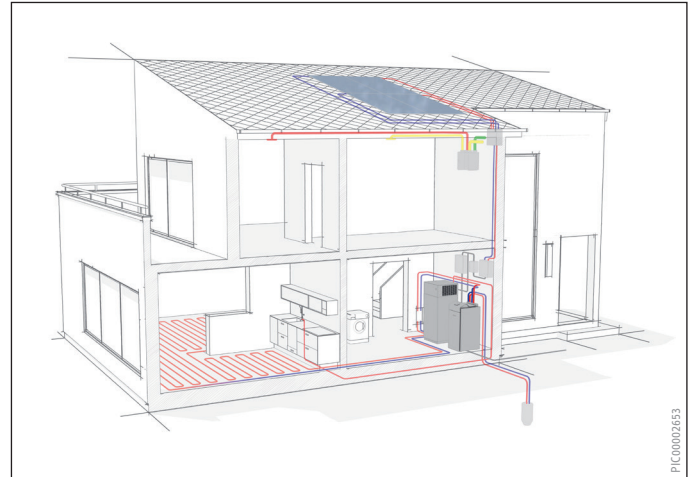

Passive cooling systems are cost effective to set up, efficient to use and can be operated without emissions.

The increasing demand for building cooling is due to higher internal and external energy loads.

Energy loads arise, for example, as a result of higher comfort demands and changes in construction methods with large transparent façades.

System solutions for heating and cooling generally involve lower investment costs than independent heating and cooling systems.

System solutions are characterised by their ability to be operated efficiently by a single control unit.

Geothermal probes are suitable for passive and active cooling.

From an economic viewpoint, geothermal probes for heating and cooling provide an additional benefit compared with heating alone.

The amount of thermal energy that can be transferred during passive cooling to a geothermal probe is approx. 70 % of the heating output of the geothermal probe.

The achievable flow temperatures are limited in passive cooling mode by the soil.

Active cooling

If particularly low temperatures are required, these can be achieved through active cooling. This is possible for example with fan convectors with flow temperatures of below 10 °C.

Cooling

Heat sinks for cooling operation

Cooling with geothermal collectors

The use of geothermal collectors for passive and active cooling is possible but requires precise engineering.

During passive cooling, due to near-surface laying and high outside temperatures, the ground can become quickly heated. The result is a considerably lower cooling capacity due to the low temperature differentials.

In most cases, passive cooling becomes impossible from a source temperature of $> 20\text{ }^{\circ}\text{C}$.

The local conditions are decisive for the utilisation of the collector for cooling purposes. The geological conditions as well as the availability of water-bearing strata determine the possibility of utilisation. A geological survey determines whether transferred heat flows can be offset by the surrounding soil, preventing it from drying out.

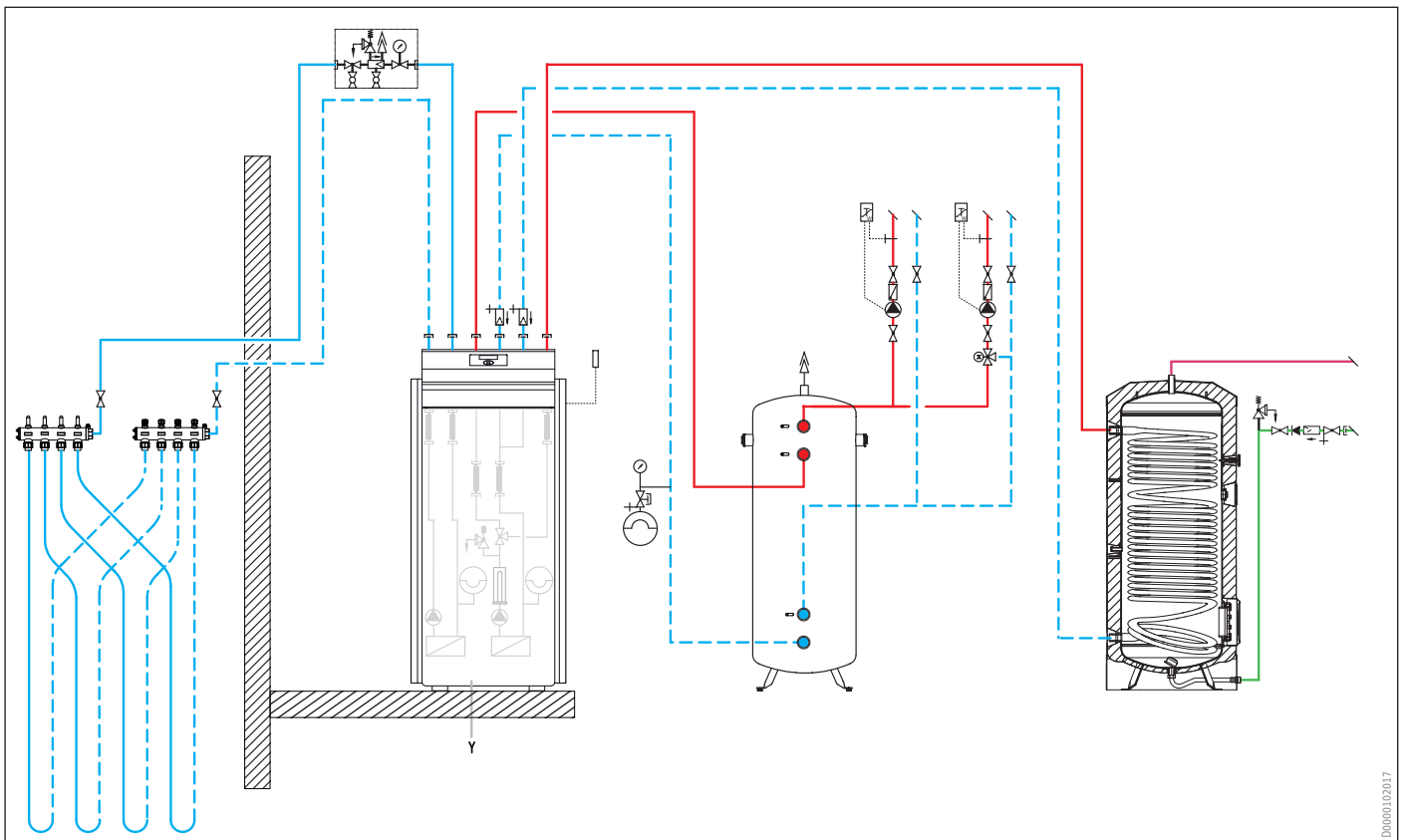

Cooling

Heat sinks for cooling operation

Cooling with groundwater

Groundwater can be used for passive and active cooling.

As a result of the stable groundwater temperature of approx. 8 °C to 12 °C, active cooling is generally not required. The output to the well system may be high.

When using groundwater for cooling, it is important to ensure that the requirements of the water board are observed. The temperature level is of significant interest here.

Depending on the specific product, an intermediate heat exchanger may be necessary for system separation. The intermediate heat exchanger must be corrosion-resistant and not vulnerable to the constituents of the water discovered during the water analysis.

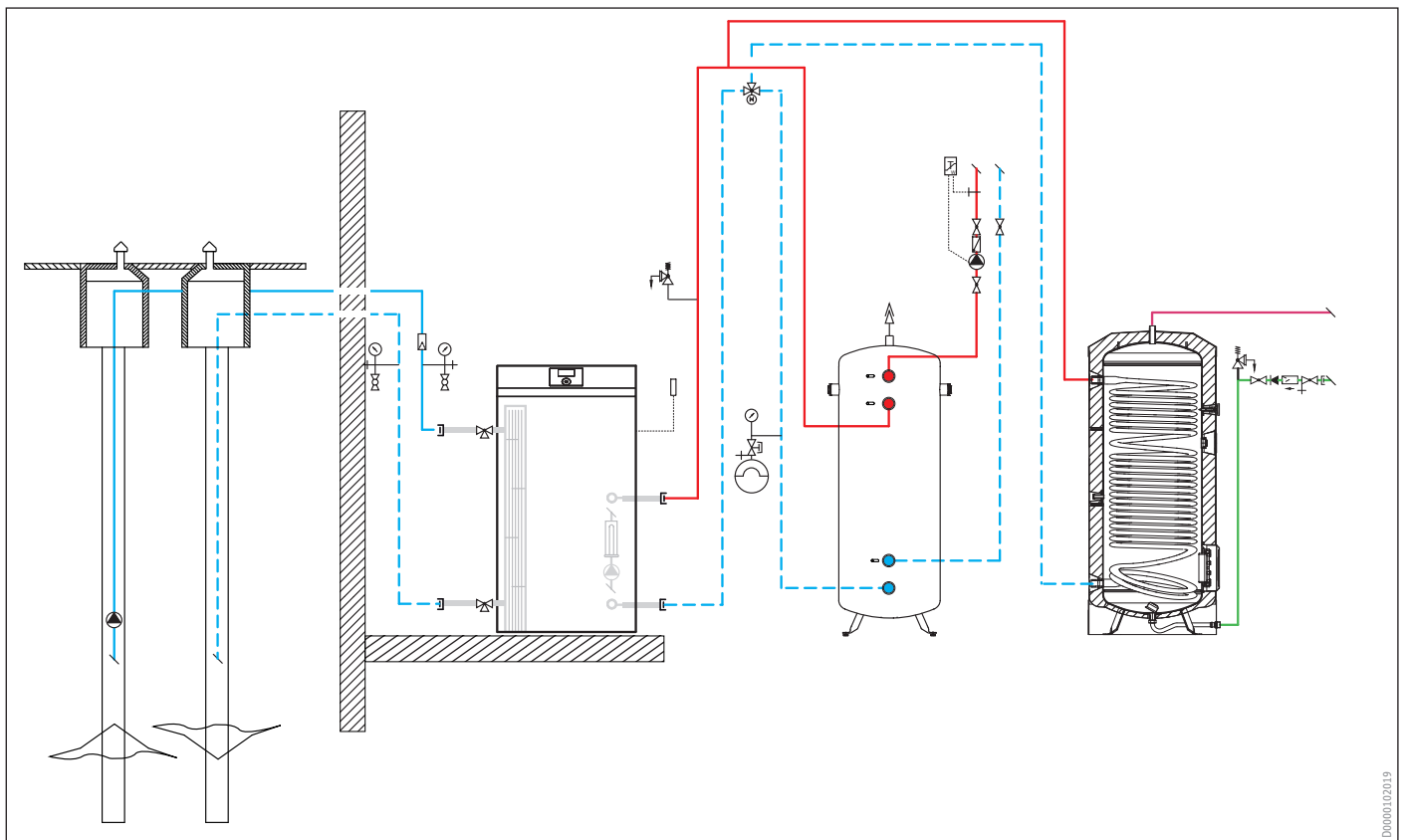

D00001.02/019

Cooling

Example designs

Cooling with groundwater

The amount of groundwater that can be utilised to remove heat is determined in accordance with the amount of groundwater required by the heat pump. The temperature differential between the groundwater and the cooling water is approx. 5 K.

Groundwater volume flow	m ³ /h	1	1.2	1.4	1.6	1.8	2.0	2.2	2.4	2.6	2.8	3.0	3.2	3.4	3.6	3.8	4.0	4.2	4.4	4.6	4.8	5.0
Transfer, cooling mode	kW	5.8	7.0	8.1	9.3	10.5	11.6	12.8	14.0	15.1	16.3	17.4	18.6	19.8	20.9	22.1	23.3	24.4	25.6	26.7	27.9	29.1

Passive cooling with a geothermal probe

Geothermal probes are sized in accordance with the heat pump heating output. 70 % of the design cooling capacity can be utilised to cover the cooling load.

Sizing table for geothermal probe DN 25

For normal solid rock, extraction rate 40 W/m (average)

Cooling capacity at B0/W35	Transfer, cooling mode	Geothermal probe	Quantity	Depth	PE pipe
kW	kW	m	-	m	mm
1.0	0.7	25	1	72	DN 25 (32 x 2.9)
2.0	1.4	50	1	50	DN 25 (32 x 2.9)
3.0	2.1	75	1	59	DN 25 (32 x 2.9)
4.0	2.8	100	2	50	DN 25 (32 x 2.9)
5.0	3.5	125	2	63	DN 25 (32 x 2.9)
6.0	4.2	150	2	75	DN 25 (32 x 2.9)
7.0	4.9	175	2	88	DN 25 (32 x 2.9)
8.0	5.6	200	3	67	DN 25 (32 x 2.9)
9.0	6.3	225	3	75	DN 25 (32 x 2.9)
10.0	7.0	250	3	83	DN 25 (32 x 2.9)
11.0	7.7	275	3	92	DN 25 (32 x 2.9)
12.0	8.4	300	4	75	DN 25 (32 x 2.9)
13.0	9.1	325	4	81	DN 25 (32 x 2.9)
14.0	9.8	350	4	88	DN 25 (32 x 2.9)
15.0	10.5	375	4	94	DN 25 (32 x 2.9)

Extraction rate 40 W/m, probe spacing: 5 m

Fill mixture for geothermal probe: 25 % by vol. ethylene glycol, 75 % by vol. water

Time in use: Up to 1800 hours p.a. (mono mode operation)

Cooling

Active cooling - air source heat pump

Active cooling with a heat pump

Air source heat pumps can also be used for cooling buildings.

The heat pump must be designed for heating operation in winter. Comparison of the heat pump cooling capacity with the building cooling load identifies the cooling options.

The sizing of the distribution system is crucial for the transfer of thermal loads. Underfloor heating systems are only suitable to a limited extent for the transfer of high loads, e.g. in conjunction with active building cooling. A combination with fan convectors is recommended.

Additional dew point monitoring in the lead room prevents condensate from forming.

Use only pipes and fittings made from corrosion-resistant materials. To avoid condensate build-up, all hydraulic lines in the building must have vapour diffusion-proof insulation.

Heat pump, mono energetic with active cooling (heating mode)

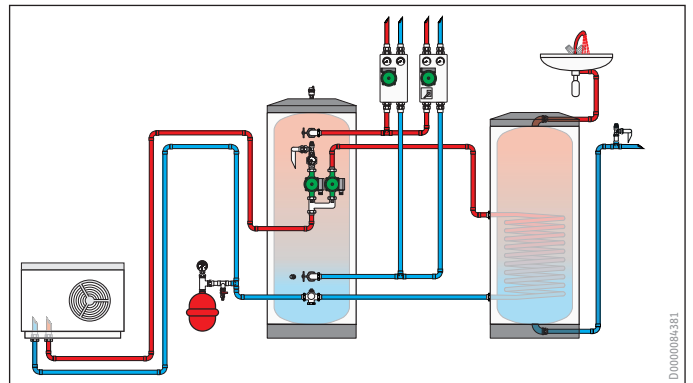

Heat pump, mono energetic with active cooling (cooling mode)

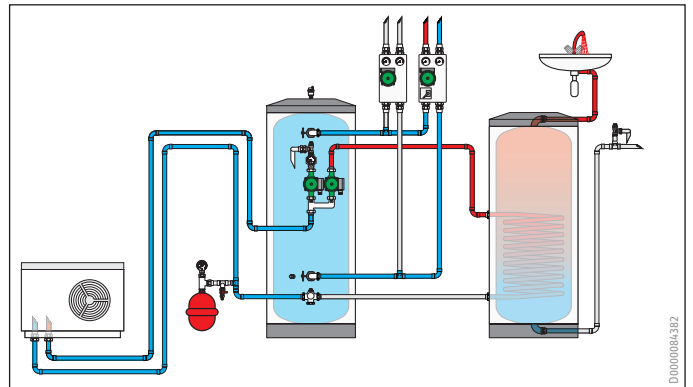

Cooling

Active cooling - ground source heat pump

Active cooling with a heat pump

Active cooling is not suitable for operation solely with underfloor/area heating systems. For active cooling, additional fan convectors must be used.

Additional dew point monitoring in the lead room prevents condensate from forming.

Use only pipes and fittings made from corrosion-resistant materials. To avoid condensate build-up, all hydraulic lines in the building must have vapour diffusion-proof insulation.

Heat pump, mono mode with active cooling (heating mode)

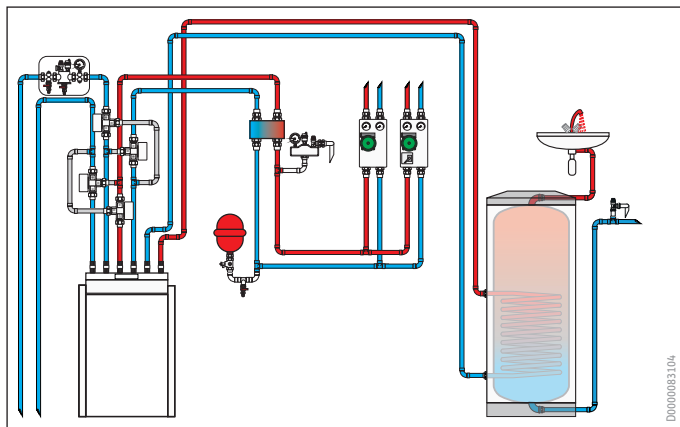

Heat pump, mono mode with active cooling (cooling mode)

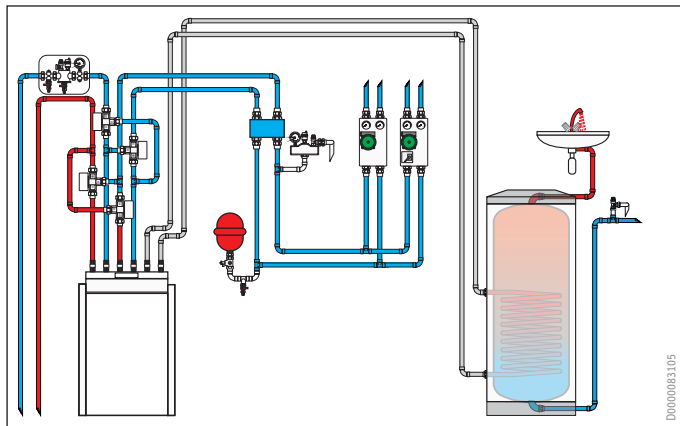

Heat pump, mono mode with active cooling (heating mode)

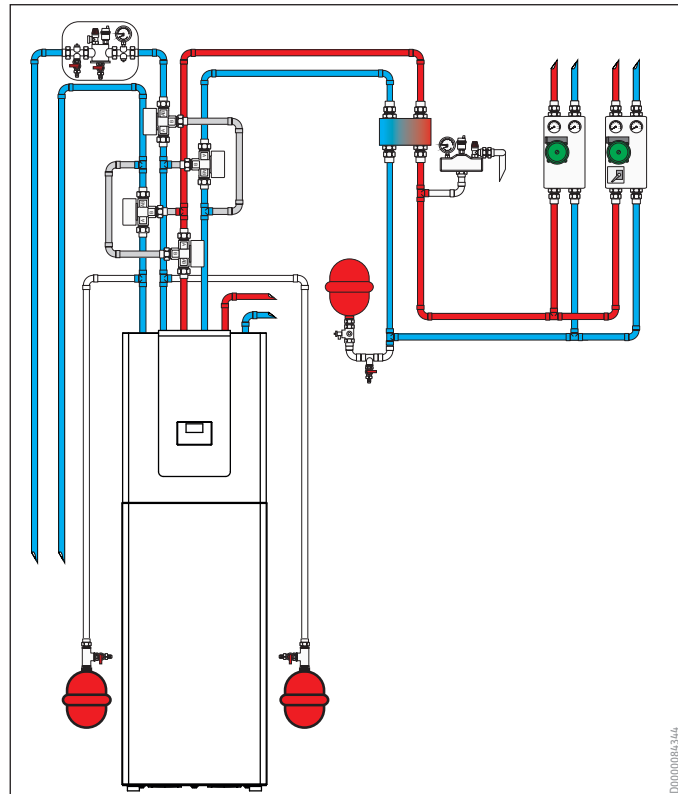

Heat pump, mono mode with active cooling (cooling mode)

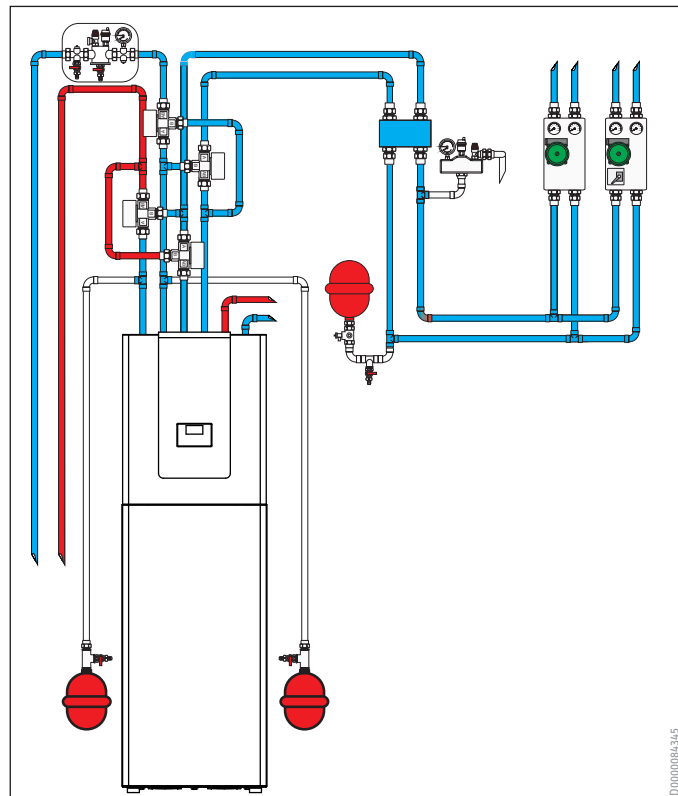

Cooling

Passive cooling - ground source heat pump

Passive cooling with a heat pump

In ground source heat pumps, the heat source can also be used for cooling. An area heating system or fan convectors are required for this function.

Additional dew point monitoring in the lead room prevents condensate from forming.

Use only pipes and fittings made from corrosion-resistant materials.

When routing through sensitive areas in the building, where the dew point temperatures may vary or may fall below the limit value, all pipework must be insulated with vapour diffusion-proof material.

Heat pump, mono mode with passive cooling (heating mode)

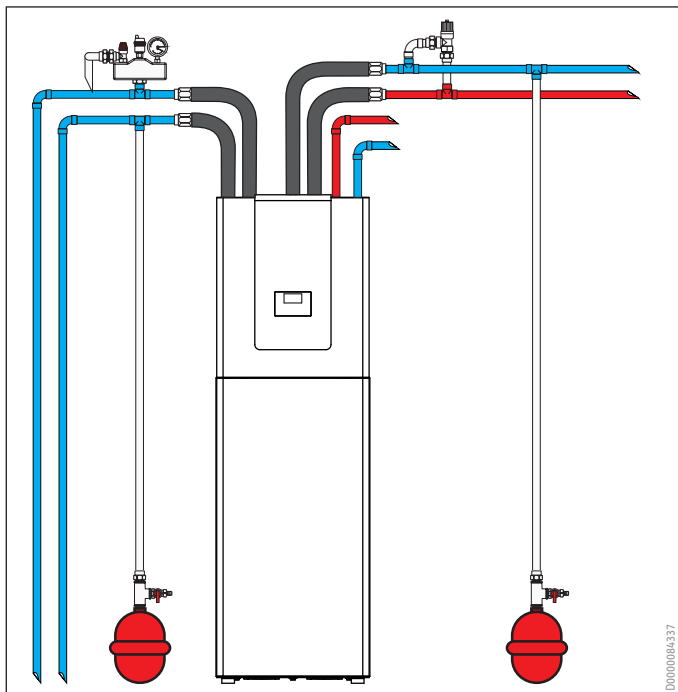

Heat pump, mono mode with passive cooling (cooling mode)

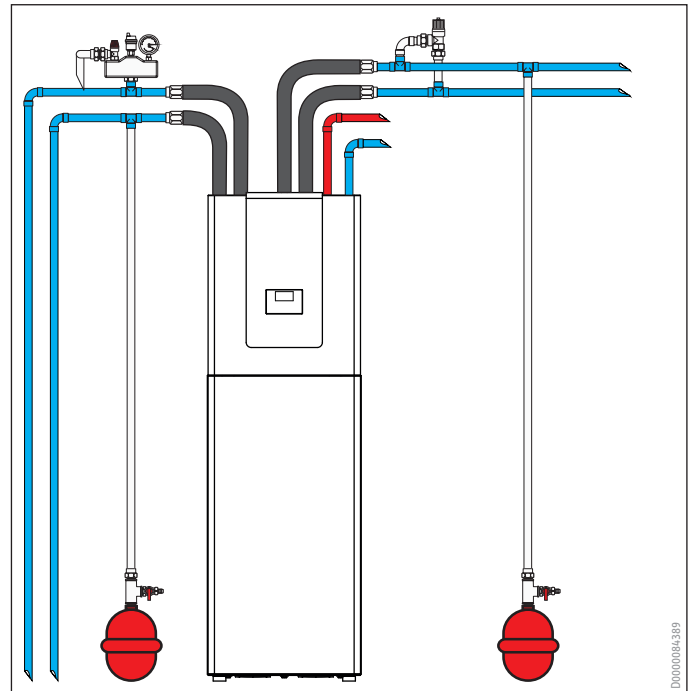

Cooling

Area cooling

Distribution systems

As with heating, sizing the cooling distribution system is an essential success factor for cooling applications. The transfer capacities and the associated temperature level are restricted in passive mode in particular. The distribution system must maximise the effect. Apart from thermo-active systems, fan convectors or ceiling cassettes are commonly used.

Thermo-active component systems

Thermo-active component systems are water-carrying pipe systems that are integrated into ceilings, walls and floors to create a comfortable room climate.

Subject to demand, buildings can be heated or cooled by circulating hot or cold water through the pipework. Based on the large heat/cold transfer surface areas, extremely low temperature differentials between the room and surface are required for effective energy supply.

Underfloor cooling

Area heating systems can also be cooled with low additional expenditure relating to regulation and system technology. Suitability of the floor structure must be confirmed by the screed manufacturer.

For passive cooling, switchable zone valves must be used.

Compared with fan convectors, underfloor systems have significantly lower transmission capacities. The cooling load of a room can often not be fully transferred. The required room temperature is not reached. In that case, the refrigeration distribution system should be limited to essential rooms.

Underfloor cooling capacity

Underfloor cooling meets the prerequisites for a comfortable room climate.

To prevent condensate on the cooling surfaces, during area cooling, the cooling water temperature must always be above the dew point temperature.

Depending on the room temperature and humidity, the room temperature can only be reduced by a few degrees Kelvin. For example, an underfloor heating system with a tiled floor covering and with a pipe spacing of 10 cm has a specific cooling capacity of just 22 W/m².

If the cooling load of the room is higher than the cooling capacity of the underfloor heating system, the required room temperature will not be reached. In such cases, either install fan convectors or limit the use to tempering the room.

Underfloor heating system cooling capacity

Floor covering		Tiles									
Spacing between pipes	cm	5	10	15	20	30	5	10	15	20	30
Room temperature	°C	27	27	27	27	27	23	23	23	23	23
Flow temperature	°C	15	15	15	15	15	15	15	15	15	15
Return temperature	°C	20	20	20	20	20	20	20	20	20	20
Cooling capacity	W/m ²	52	45	39	34	26	26	22	19	17	13

Underfloor heating system heating output

Floor covering		Tiles					Carpet				
Spacing between pipes	cm	5	10	15	20	30	5	10	15	20	30
Room temperature	°C	20	20	20	20	20	20	20	20	20	20
Flow temperature	°C	35	35	35	35	35	35	35	35	35	35
Return temperature	°C	30	30	30	30	30	30	30	30	30	30
Heating output	W/m ²	65	55	50	45	30	40	37	32	28	24

Cooling

Ceiling cooling

Ceiling cooling

Ceiling cooling systems are suitable for cooling with heat pumps. Cooling capacities of cooling ceilings are higher than those of underfloor heating systems. This is because, among other things, the heat transfer to the room varies.

The room temperature should not fall below 21 °C at a height of 0.1 m above the floor.

Room cooling through pipe banks integrated into the ceiling works in the same way as underfloor cooling. Cold water circulates through the pipework and thereby extracts heat from the room.

Ideal application areas for chilled ceilings are, for example, industrial buildings, shopping centres, libraries, offices or banks. These buildings have high rooms where ventilation systems are operated to help maintain room hygiene.

As a result of the mechanical regulation of the air condition and the independence from minimum air temperatures, cooling ceilings can transfer substantially higher cooling capacity than underfloor heating systems. Achievable specific cooling capacities are between 40 and 80 W/m².

Only clear ceiling surfaces help to optimise the room climate. Ceiling cladding or suspended ceilings have a negative effect on cooling.

Ceiling panels

The market offers various ceiling panels that have the structure of a thermally active panel with a covering insulating layer. These ceiling panels are preferably installed in a conventional grid ceiling with metal rail substructure.

Chilled ceiling (thermo-active component)

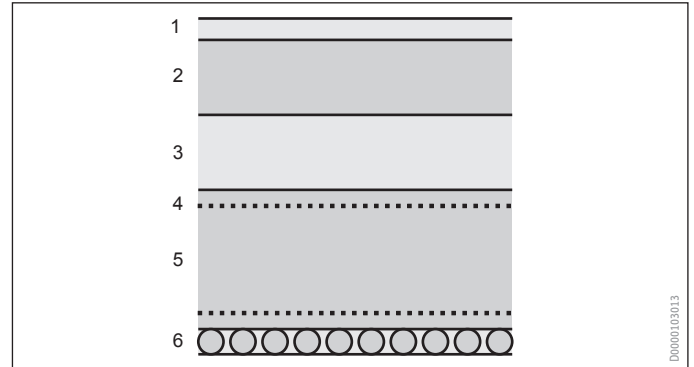

- 1 Floor covering
- 2 Screed
- 3 Insulation
- 4 Reinforcement
- 5 Ceiling
- 6 Plaster

Concrete core activation

If buildings are designed and built architecturally and structurally for optimised energy efficiency, then there is no need for cooling units for building cooling. The building can be cooled via natural heat sinks. Natural heat sinks are the soil and groundwater.

A prerequisite for this is that the inherent storage capacity of the building can be utilised for balancing temperatures.

To provide concrete cores activation, the pipe banks are generally located in the structurally neutral zones of the surfaces surrounding the room. The pipe banks are cast into the concrete core in meander or spiral form.

Materials used are plastic or multi-layered composite pipes made from PE and aluminium. The pipes have a diameter of 15 to 20 mm. Pipe spacing is 10 to 30 cm.

The water flowing through the pipe banks can be used for heating or cooling operation.

The prerequisite for good energy transfer is low thermal resistance values of the layers above the pipe banks. Transferable cooling capacities lie between 30 and 40 W/m². Similarly to underfloor and ceiling cooling, the cooling capacity is limited by the dew point of the room temperature.

Heating and cooling via concrete core activation can contribute to thermal comfort inside the building. Improvements in the indoor air quality or targeted control of the relative humidity inside the room are not feasible.

Compared to underfloor and ceiling heating systems, concrete core activation is a very inert system.

Suitable storage and load management is required to safeguard the optimum capability of the system.

Advantages of thermo-active component systems

- » Heating and cooling operation with one system
- » Optional utilisation of renewable energy sources
- » Affordable and energy efficient operation
- » Maintenance-free
- » Unrestricted interior design
- » Quiet operation and no sensations of draughts
- » No renovation or cleaning effort required for the heating and cooling surfaces
- » High degree of thermal comfort because of low surface temperatures

Concrete core activation

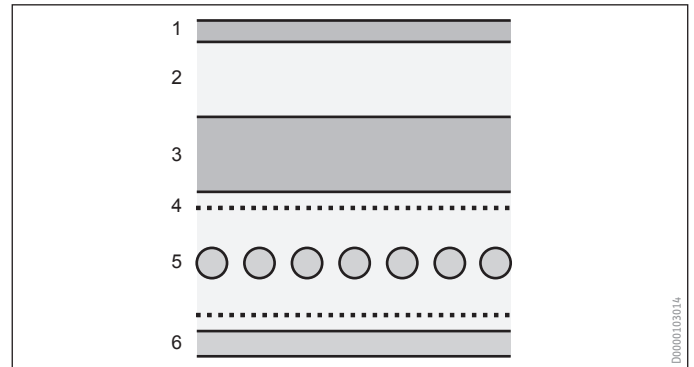

- 1 Floor covering
- 2 Screed
- 3 Insulation
- 4 Reinforcement
- 5 Ceiling
- 6 Plaster

Disadvantages of thermo-active component systems

- » Limited cooling capacity due to limited flow temperatures (monitoring the dew point)
- » Control to a precise set room temperature is impossible because of the large thermal mass and the inertia of concrete core activation.
- » Concrete core activation cannot be used as part of modernisation projects.
- » No control over the room air quality and relative humidity.
- » The following applies to ceiling heating systems and concrete core activation (concrete ceilings) alike: Covering ceilings or suspended ceilings should be avoided to safeguard the optimum heating and cooling capacity.

Cooling

Fan convectors and cassette units

Fan convectors and cassette units

Fan convectors and cassette units are commonly used for cooling buildings.

The cooling water temperatures lie between +7 °C and +20 °C.

With fan convectors and cassette units, the cooling water temperature can be reduced to below the dew point and can extract sensible heat, as well as latent heat, from the indoor air through condensate formation.

Fan convectors and cassette units are equipped with a condensate drain. Distributor pipes and components must have vapour diffusion-proof insulation.

The cooling capacity of a fan convector or a cassette unit is subject to the size, air flow rate and cooling water temperature.

Fan convector



Cassette unit

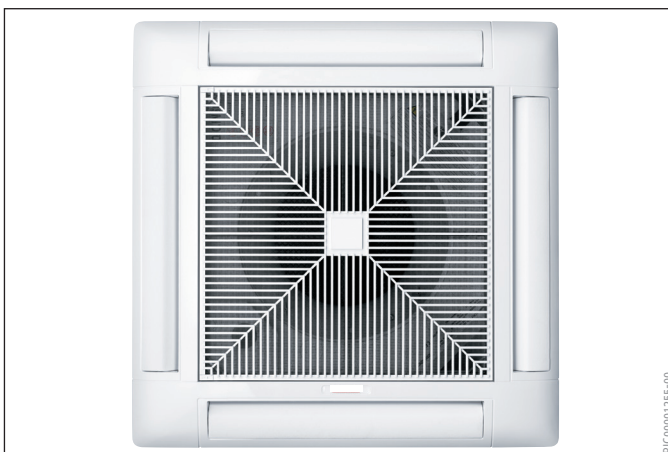

Notes

Sound

Sound power, sound power level

Sound emissions

In operation, any heat pump system will generate some noise. People can perceive operating noise as a disturbance. Operating noise should be minimised as much as possible.

Before choosing a product, an analysis of the conditions and calculation of the expected noise development should be carried out.

Basics

A tone, sound or noise are all described as sound. A tone is a single constant vibration. A sound is several tones laid over each other. A noise is an irregular vibration with many frequencies.

Sound spreads in the form of mechanical waves. Sound waves spread out evenly in circular formation. The speed of sound waves depends on the mechanical properties of the carrier medium.

If a sound wave hits an obstacle, the sound wave is reflected at the same angle as that with which it hit the obstacle.

How much of the sound energy is absorbed is determined by the material of the obstacle. Concrete is a hard material that absorbs sound energy poorly. Soft, open pored materials convert a large proportion of sound energy into frictional heat.

If two sound waves collide, they can overlay each other. Overlaying can weaken or amplify the sound waves.

Sound power

Sound power is a fundamental acoustic parameter of an appliance. The sound power of an appliance is not dependent on a specific distance, the directional characteristics of the sound source or the test environment.

Sound power level

Sound power is an ideal basis for a neutral comparison of appliances. The sound power level is not subject to environmental influences or the test distance and is only influenced by the operating state of the sound source.

Sound power is specified in watts. It is tested under laboratory conditions. As the values are in the micro watt range, the logarithmic magnitude is referred to in decibels (dB).

$$L_W = 10 \log_{10} \left(\frac{P}{P_0} \right) \text{ dB}$$

L_W	Sound power level in dB
P	Sound power in W
P_0	Standardised reference value in W

Frequency weighting (A)

The sound power level is subjected to a frequency weighting in order to take the frequency response of human hearing into account.

Weighting is carried out with an (A) after the unit.

Relevant guidelines and regulations most frequently apply the (A) weighting.

Sound

Sound pressure level

Sound pressure level

Sound pressure level describes the pressure fluctuations in a sound transfer medium.

Human perception of "sound volume" is the sound pressure level.

The sound pressure level is lower than the static air pressure by a multiple factor.

The sound pressure level is expressed in pascals. As the values are in the micropascal range, the logarithmic magnitude is referred to in decibels (dB).

$$L_p = 10 \log_{10} \left(\frac{\tilde{p}^2}{p_0^2} \right) \text{dB} = 20 \log_{10} \left(\frac{\tilde{p}}{p_0} \right) \text{dB}$$

- L_p Sound pressure level in dB
- \tilde{p} Effective sound pressure level in Pa
- p_0 Standardised reference value in Pa

Measuring the sound pressure level

When measuring the sound pressure level, the distance from the sound source, as well as the test environment, must be taken into consideration.

The background sound level in the test environment must also be taken into account.

Calculating the sound pressure level

The sound pressure level can be calculated from the sound power level:

$$L_{pA} = L_{WA} + 10 \log_{10} \left[\frac{Q}{(4 * \pi * d^2)} \right]$$

- $L_{pA} = A$ Weighted sound pressure level in dB(A)
- $L_{WA} = A$ Weighted sound power level in dB(A)
- Q Correction factor
- d Distance in m

The distance (d) and the ambient conditions (Q) must be taken into consideration. Correction values are applied when considering the ambient conditions.

Correction values	Q
Wall installation	6
Corner installation	9

Sound power level differential subject to distance and installation conditions

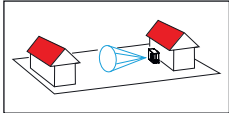
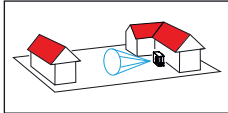
Dis- tance	Wall installation	Corner installation
	Q = 6 dB(A)	Q = 9 dB(A)
		
1	2.0 dB(A)	1.0 dB(A)
2	8.0 dB(A)	5.0 dB(A)
3	11.5 dB(A)	8.5 dB(A)
4	14.0 dB(A)	11.0 dB(A)
5	16.0 dB(A)	13.0 dB(A)
7	19.9 dB(A)	15.9 dB(A)
10	22.0 dB(A)	19.0 dB(A)
15	25.5 dB(A)	22.5 dB(A)
20	28.0 dB(A)	25.0 dB(A)

Sound

Law of Distance

Law of Distance

The sound pressure level is reduced by approx. 6 dB if the distance d doubles in length.

$$\Delta d = d_2 - d_1 = \left[10 \log_{10} \left(\frac{P_2}{P_0} \right)^2 - 10 \log_{10} \left(\frac{P_1}{P_0} \right)^2 \right] \text{ dB}$$

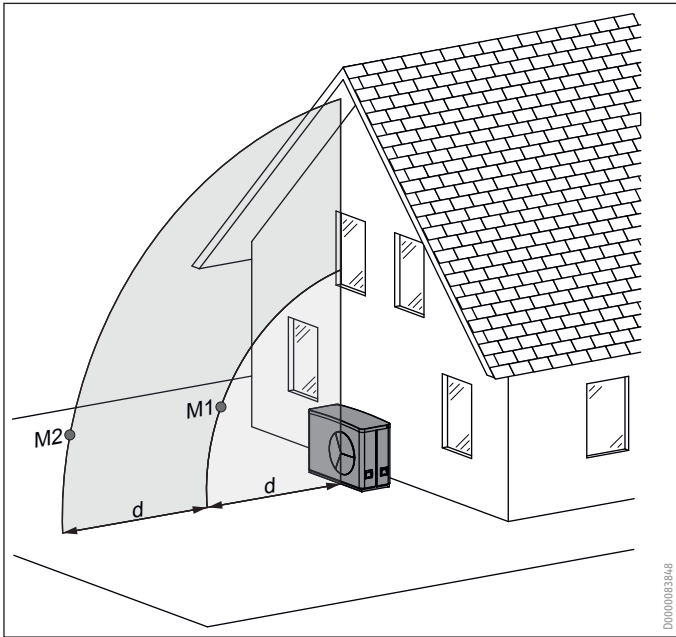

Example

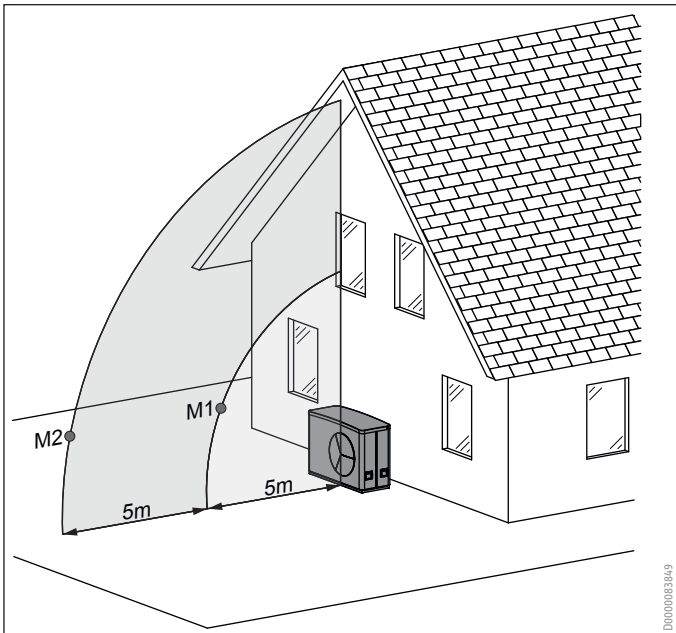

L_W Sound power level = 60 dB(A)
 M_1 Sound pressure level L_{pA1} (5 m distance) = 44 dB(A)
 M_2 Sound pressure level L_{pA2} (10 m distance) = 38 dB(A)

Human perception of the sound pressure

If a noise is perceived to be twice as loud, this corresponds to an increase of approx. 10 dB from 40 dB.

Two equal sound sources (sound pressure of a cascade)

If the level is doubled, this corresponds to an increase of 3 dB.

Germany: TA-Lärm

The "Technische Anleitung zum Schutz gegen Lärm" (TA-Lärm) is a general administrative regulation in Germany. It is designed to protect the general public and neighbouring properties against detrimental environmental influences through noise. The TA-Lärm builds the foundation for approval processes for commercial and industrial plant. The TA-Lärm is not compulsory for family homes or apartment buildings. It is generally used as a basis for assessments in cases of disputes.

If an appliance is sited in a garden in a residential area, a specific limit value must not be exceeded at the "place of immission". A possible place of immission is, for example, a neighbour's window.

In built-up areas, select a test point that lies 0.5 m outside the centre of the open window of the area most affected by the noise that is to be protected. An area that is to be protected is, for example, a bedroom.

The following values must not be exceeded at the neighbour's windows:

Commercial residential areas	dB(A)
6:00 - 22:00	60
22:00 - 06:00	50
General residential areas	dB(A)
6:00 - 22:00	55
22:00 - 06:00	40
Exclusively residential areas	dB(A)
6:00 - 22:00	50
22:00 - 06:00	35

Country comparison

In France, regulation N° 2006-1099 dated 31 August 2006 applies to anti-noise measures in neighbourhoods. This regulation specifies limits between ambient noise and the residual noise, comprising normal interior and exterior noise in a given location.

Limits	Max. dB(A)
7:00 - 22:00	5
22:00 - 07:00	3



Note

Observe the standards and regulations applicable in your country.

Sound

Noise propagation and structure-borne sound

Acoustic measures

Lawn areas and shrubs help reduce the spread of noise. Do not site the appliance on particularly reverberant surfaces. Large, reverberant floor areas can reflect sound and raise sound levels by up to 3 dB(A) compared with positioning on insulated floors.

Direct sound spread

With freestanding positioning, the direct spread of sound can be reduced by structural obstacles. Noise levels can be reduced by walls, fences, palisades, etc.

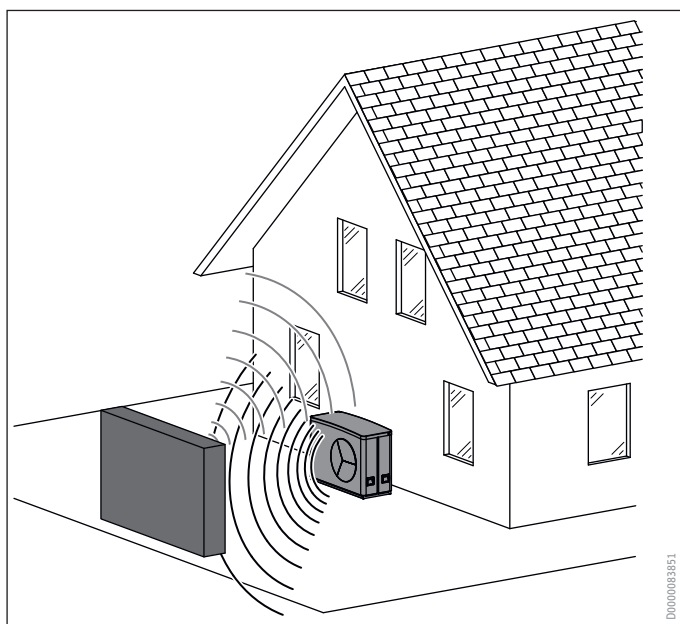
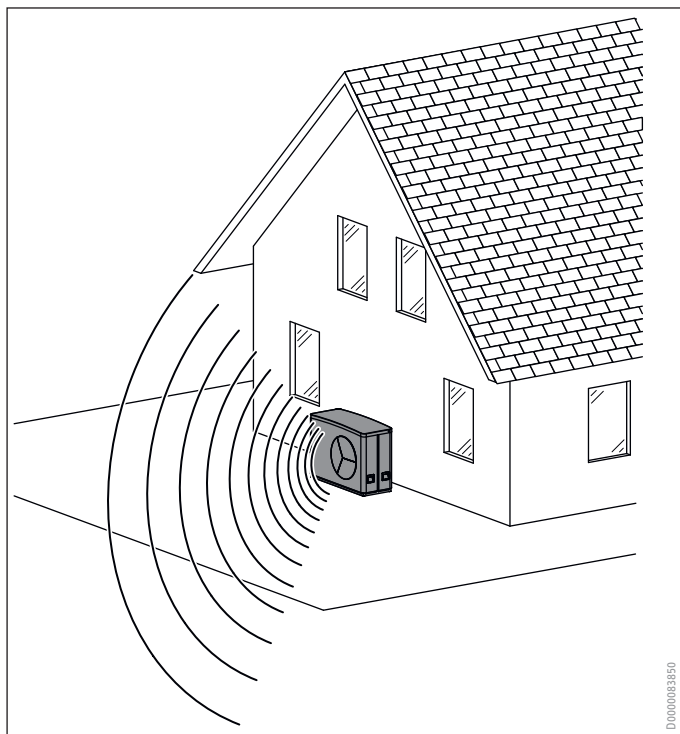

Structure-borne sound

The transfer of structure-borne sound through heating pipes to brickwork and radiators should be prevented.

- » Heat pumps should therefore be connected to the heat distribution system via flexible hoses.
- » Pipework on walls and ceilings must be insulated to prevent structure-borne sound and have flexible connections.
- » Pipework through walls and ceilings must be insulated to prevent structure-borne sound.

Decision making guide

The simplest option to decide whether to use a heat pump installed outdoors in accordance with the prevailing conditions on site is a separate calculation of the sound pressure level at the required distance.

The only essential information required for this is the sound power level of the selected appliance and the corresponding correction factor for the ambient conditions.

This data can be used to determine the calculated sound pressure level for any required distance to the appliance.

The sound pressure level alone at defined distances is not ideal for a neutral and reliable assessment, because local conditions are not taken into account.

Air routing

Incorrect structural integration can lead to undesirably high noise levels.

If the following points are observed, air routing should not cause any problems:

- » Prevent air being discharged directly towards neighbouring properties.
- » Prevent air being discharged directly towards house or garage walls.
- » The expected sound pressure level at the installation site and at neighbouring properties have been checked in advance.
- » Never install the appliance immediately adjacent to living rooms or bedrooms.

Design information

- » Plants can reduce reflections as the sound has to travel through multiple obstacles.
- » Do not site the appliance on particularly reverberant surfaces.
- » Siting between two enclosed walls, as well as in corners and recesses, can lead to increased noise levels.
- » Reductions in noise levels can be achieved through on-site deflectors.

Notes

Air source heat pumps - outdoor installation

Condensate drain

Condensate drain

Air source heat pumps extract moisture from the outdoor air. The moisture freezes on the cold evaporator fins to form ice. The ice is defrosted and drained away as condensate. The evaporator is defrosted as required. Condensate occurs in phases.

The following points must be observed for the engineering and installation of the condensate drain:

- » Route the condensate drain hose out of the heat pump with a steady fall.
- » Route the condensate via a frost-free drain. Allow the condensate to drain into a coarse gravel soakaway.
- » Maintain the recommended sizes such as for the foundation and gravel bed thicknesses.
- » If the condensate drain pipe is not laid such that it is free from the risk of frost, or if a T-support or wall mounting bracket is used, consider the use of a ribbon heater.
- » Lay the ribbon heater directly in the condensate drain.
- » Check whether the planned product and accessories include a ribbon heater.

Natural condensate drainage

For heat pumps with natural condensate drainage, a sufficiently large surface must be provided for soakaway.

- » Where possible, use black or dark grey coarse gravel.
- » Ensure controlled condensate drainage to prevent ice formation on adjacent footpaths.

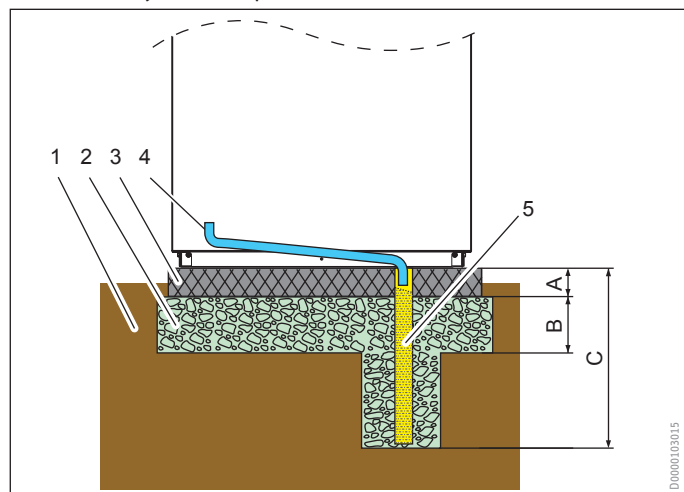

1	Ground	A	10 cm
2	Coarse gravel soakaway	B	30 cm
3	Concrete slab	C	80 cm
4	Condensate drain pipe		
5	Condensate drain conduit		

Condensate drainage into a downpipe or sewer

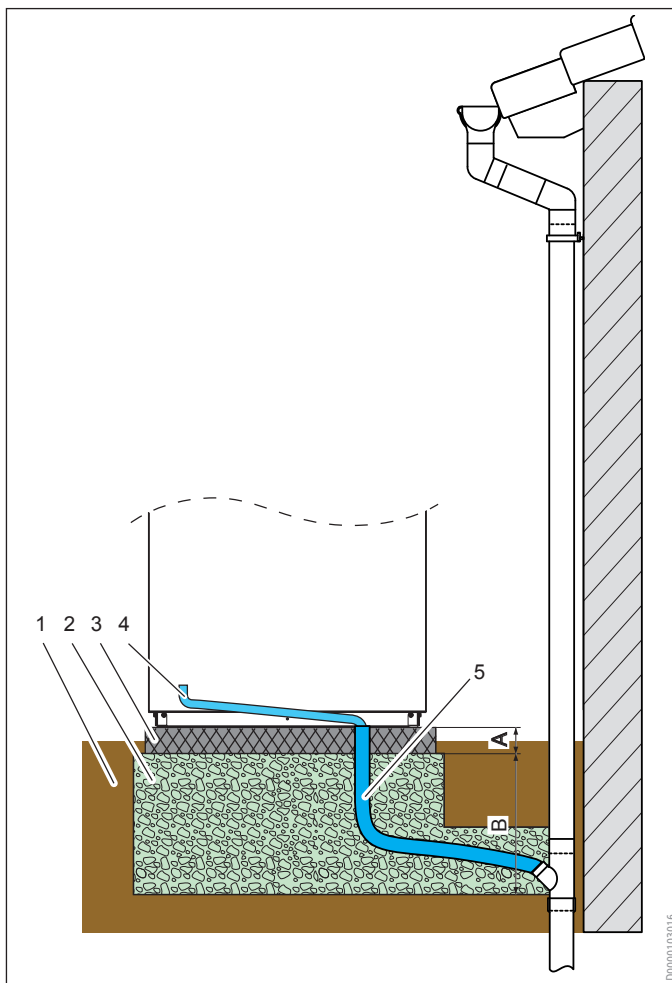

1	Ground	5	Condensate drain
2	Coarse gravel soakaway	A	10 cm
3	Concrete slab	B	80 cm
4	Condensate drain hose		

Air source heat pumps - outdoor installation

Checklist, air source heat pumps, outdoor installation

Air source heat pumps, outdoor installation

- » Has a check been carried out to ascertain whether the heat pump installation site requires authorisation?
- » Does the installation site meet sound insulation requirements?
- » Has the heat pump been sited according to the installation conditions.

Heat generation

- » Have the results of the heat load calculation been taken into consideration?
- » Have the results of the cooling load calculation been taken into consideration?
- » Has a check been carried out to ascertain whether the installation of the heat pump system requires the prior authorisation of the local energy suppliers?
- » Is the availability of the necessary power supply guaranteed?
- » Have the requirements of the energy suppliers been met?
- » Have the maximum power consumption levels during heat pump start-up been taken into consideration?
- » Have the installation site requirements been met?
- » Have measures been taken to ensure that the selected heat pump will cover both the heating load and the cooling load
- » Has the second heat generator been incorporated in accordance with the system design?
- » Have the DHW heating requirements been met?
- » Has the possibility of frost damage been ruled out?
- » Is there access for installation and maintenance work?
- » Have the necessary measures been taken to reduce noise emission?
- » Has the heat pump system been fitted with appropriate safety equipment?
- » Has any necessary equipment been provided for monitoring operating conditions?
- » Have the individual design stages been documented?
- » Has the heat distribution system been designed based on the heat load and heat pump output?
- » Has a check been carried out to ascertain whether it is necessary to split the entire heat distribution system among multiple distributor circuits?
- » Can the planned number of consumers be covered by the control unit?
- » Has any higher ranking control unit been taken into consideration in the design?
- » Have the individual heating circuits been designed based on the temperature level of the heat pump?
- » Have the individual cooling circuits been designed based on the temperature level of the heat pump?
- » Is dew point monitoring of the individual cooling circuits guaranteed?
- » Has any necessary buffer cylinder system been taken into consideration?

Air routing

Air routing

The connection on the air side is routed outside using flexible air hoses or via air ducts with flexible connections.

Max. air velocity	m/s	4
-------------------	-----	---

Always prevent air "short circuits" between the air intake and air discharge. It would be practical to draw in air from around the corner or crosswise. If the intake and discharge openings are at the same level, ensure a minimum distance between them.

Minimum clearance	m	3
-------------------	---	---

If necessary, provide a separating wall or suitable plantings between the air intake and the air discharge.

Cellar - in a corner

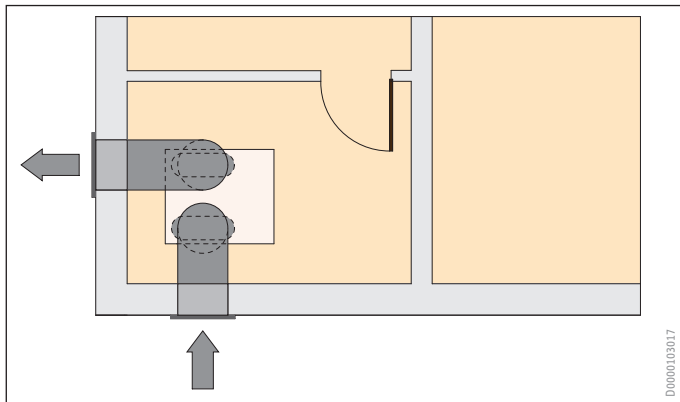

The example shows the siting of a compact heat pump in a cellar corner. This positioning of air intake and discharge prevents thermal short circuits.

Cellar - separate ducts

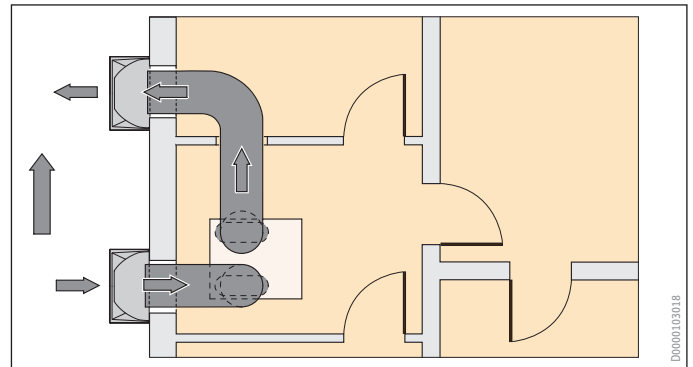

If the distance of light wells is sufficient to prevent a thermal short circuit, it is possible to connect the air ducts on one side of the building.

Protect the air intake and air discharge ducts against leaves and snowfall.

Cellar - common duct

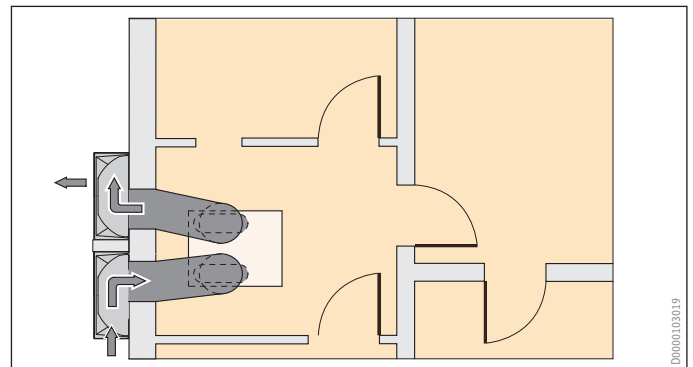

If a thermal short circuit can be prevented, the air ducts can be connected to a common light well.

In this example, the intake air flow is diverted. A dividing wall between the air intake and air discharge inside the light well and an air deflector outside the light well prevent a thermal "short circuit".

The following points must be observed:

- » Avoid thermal "short circuits".
- » Ensure condensate drainage.
- » Provide an unrestricted cross-section of adequate size for the air intake and discharge grilles.

Distributing the external pressure

When sizing air ducts and grilles, observe the external pressure of the fan.

At least 20 % of the total external fan pressure must additionally be taken into account for the air discharge side.

Air routing

Indoor installation

The connection on the air side is routed outside using flexible air hoses.

Incorrect structural integration can lead to undesirably high noise levels.

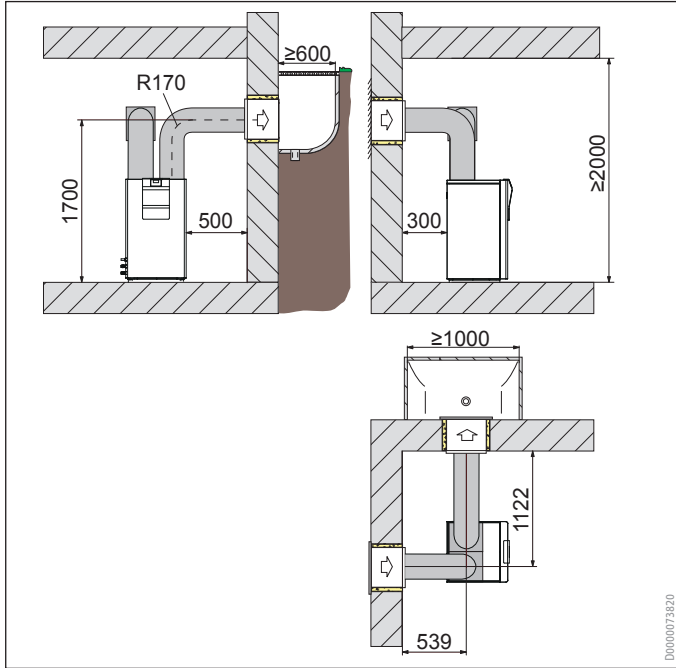

Sample installation

A wall outlet is installed in the external wall. The air duct system connects the heat pump to the external wall.

The air flow creates vibrations in the air hoses. All retainers and the wall outlets must be designed to ensure insulation against structure-borne sound.

If wall outlets are below ground level, air must be routed via light wells with a level surface.

Inadequately sized air hoses, poor air routing or the position of air outlets cause pressure drops. At the very least, excessively high pressure drops lead to efficiency losses and higher noise emissions. In the worst case scenario, the heat pump can fail.

To reduce sound emissions, silencers can be incorporated into the air duct system. Silencers are used on the discharge side. An air line with a minimum length of 2 m is required when installing a silencer.

Design information

- » The heat pump should not be sited below or adjacent to bedrooms.
- » On reverberant floors, e.g. tiles, we recommend placing a suitable rubber mat under the heat pump.
- » Better sound insulation can be achieved by using a concrete plinth with a rubber mat under the appliance.
- » Insulate pipe outlets through walls and ceilings against structure-borne noise transmission.

Air source heat pumps - indoor installation

Condensate drain

Condensate drain

For condensate drainage, a suitable hose must be connected to the heat pump condensate pan.

The condensate drain hose must be routed out of the heat pump with a fall.

Condensate must be routed into a drain.

If a condensate pump is used, the heat pump must be approx. 100 mm higher or the condensate pump approx. 100 mm lower.

Condensate drain

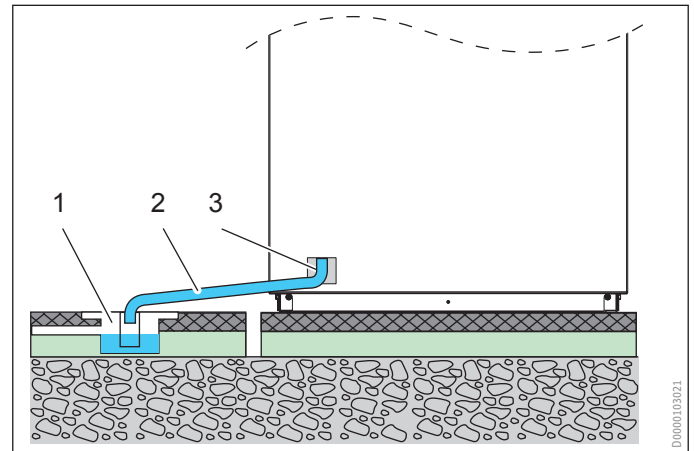

- 1 Drain with stench trap
- 2 Drain hose with a steady fall
- 3 Condensate drain connection

Condensate drainage with condensate pump into a drain

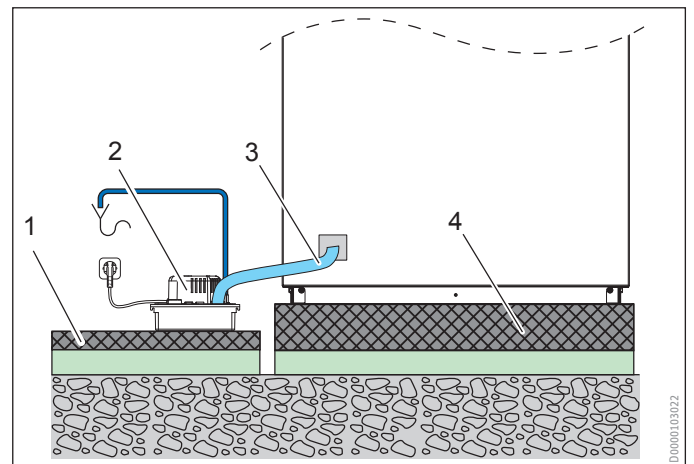

- 1 Screed and cover
- 2 Impact sound insulation
- 3 Condensate drain pipe
- 4 Plinth

Air source heat pumps - indoor installation

Checklist, air source heat pumps, indoor installation

Air source heat pumps, indoor installation

- » Has a check been carried out to ascertain whether the heat pump installation site requires authorisation?
- » Does the installation site meet sound insulation requirements?
- » Has the heat pump been sited according to the installation conditions.
- » Has air routing engineering been completed?
- » Has a thermal short circuit been ruled out during air routing?
- » Was fire safety observed for air routing?

Heat generation

- » Have the results of the heat load calculation been taken into consideration?
- » Have the results of the cooling load calculation been taken into consideration?
- » Has a check been carried out to ascertain whether the installation of the heat pump system requires the prior authorisation of the local energy suppliers?
- » Is the availability of the necessary power supply guaranteed?
- » Have the requirements of the energy suppliers been met?
- » Have the maximum power consumption levels during heat pump start-up been taken into consideration?
- » Have the installation site requirements been met?
- » Have measures been taken to ensure that the selected heat pump will cover both the heating load and the cooling load
- » Has the second heat generator been incorporated in accordance with the system design?
- » Have the DHW heating requirements been met?
- » Has the possibility of frost damage been ruled out?
- » Is there access for installation and maintenance work?
- » Have the necessary measures been taken to reduce noise emission?
- » Has the heat pump system been fitted with appropriate safety equipment?
- » Has any necessary equipment been provided for monitoring operating conditions?
- » Have the individual design stages been documented?
- » Has the heat distribution system been designed based on the heat load and heat pump output?
- » Has a check been carried out to ascertain whether it is necessary to split the entire heat distribution system among multiple distributor circuits?
- » Can the planned number of consumers be covered by the control unit?
- » Has any higher ranking control unit been taken into consideration in the design?
- » Have the individual heating circuits been designed based on the temperature level of the heat pump?
- » Have the individual cooling circuits been designed based on the temperature level of the heat pump?
- » Is dew point monitoring of the individual cooling circuits guaranteed?
- » Has any necessary buffer cylinder system been taken into consideration?

Geothermal heat pumps

Brine mixture

Frost protection and mixing ratio

Ethylene glycol was developed for use as a heat and cooling transfer medium. The frost protection is subject to its mixing ratio with water.

If the mixing ratio is 25 % ethylene glycol with 75 % water, the medium remains liquid down to $-18\text{ }^{\circ}\text{C}$. The bursting effect begins at $-25\text{ }^{\circ}\text{C}$.

Subject to the mixing ratio, the system pressure drop will also change.

The pressure drop curve indicates that the pressure drop of a 25/75 mixture increases, compared to water, by a factor of 1.5. This must be taken into consideration when designing the circulation pump.

Frost protection of the brine mixture

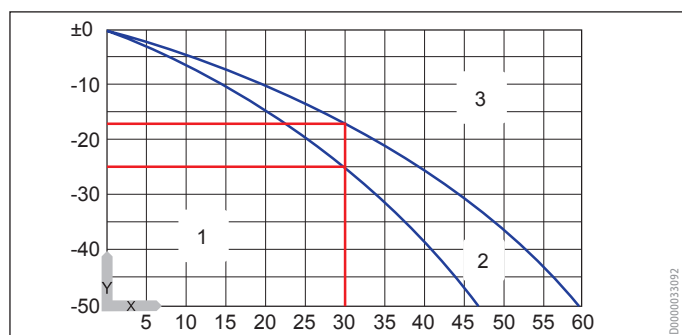

- x Based on %: Ethylene glycol
- y Frost protection ($^{\circ}\text{C}$)
- 1 Bursting effect on falling below the frost protection limit (solid)
- 2 Icy mush
- 3 Liquid

Increase in pressure drop of the brine mixture

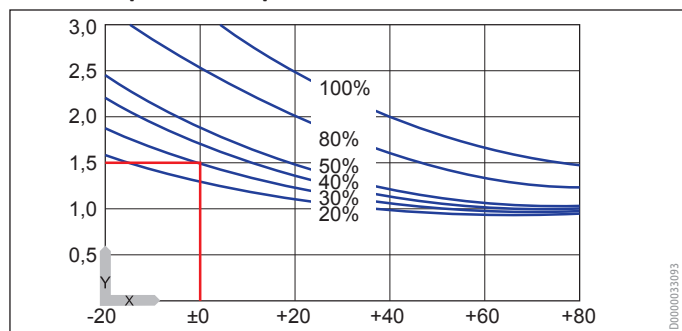

- x $^{\circ}\text{C}$
- y Pressure increase factor
- % Based on: Ethylene glycol

Permissible heat transfer media

The following heat transfer medium is permissible for our heat pump systems.

- » Heat transfer medium as concentrate on an ethylene glycol base



Note

When using the heat transfer medium as a premixed formulation, hemp may not be used for sealing in the heat source system.

Circulation pump and required flow rate

A suitable brine circulation pump must be used for the brine supply.

The brine circulation pump must be designed in accordance with the system-specific conditions.

The nominal flow rate and the pressure drops must be taken into consideration.

A sufficient flow rate must be guaranteed at all brine temperatures.

The nominal flow rate relates to a brine temperature of $0\text{ }^{\circ}\text{C}$ with a tolerance of $+10\text{ }%$.

Total volume

The overall volume equals that of the required amount of brine that should be mixed from undiluted ethylene glycol and water.

Heat pump performance details

The stated performance details refer to ethylene glycol.

Geothermal heat pumps

Brine mixture

Frost protection

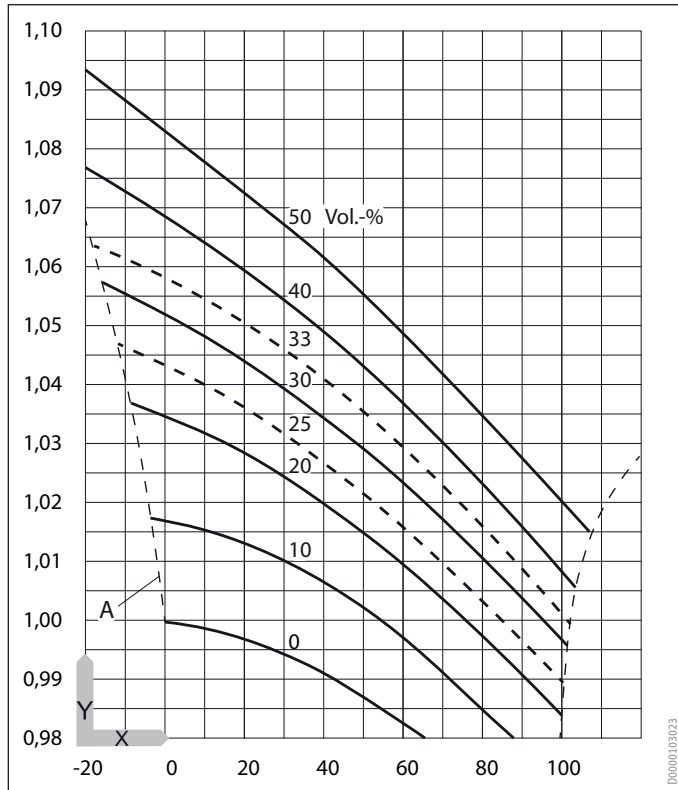

X Temperature [°C]
 Y Density [g/cm³]
 A Frost protection [°C]

Mixing ratio

The brine concentration varies depending on whether a geothermal collector or a geothermal probe is used as the heat source. The table shows the respective mixing ratios.

Collector type		Ethylene glycol	Water
Geothermal probe	%	25	75
Geothermal collector	%	33	67

Application limit for water		
Chloride content of the water	Max. ppm	300

Checking the brine concentration:

- » With a hydrometer, establish the density of the ethylene glycol mixture.
- » The concentration based on the measured density and brine temperature can be found on the diagram.

Design information

- » The heat source system for ground source heat pumps must be implemented according to our technical guides.
- » All brine lines must have diffusion-proof thermal insulation.
- » To prevent the transmission of noise, connect the heat source circuit to the heat pump with flexible pressure hoses.
- » Prior to connecting the heat pump, check the heat source circuit for possible leaks, and flush thoroughly.

Geothermal heat pumps

Geothermal collector

Geothermal collector

Collectors laid in the ground supply the heat pump with energy. A frost-proof heat transfer medium circulates in the collectors. The heat transfer medium extracts energy from the ground.

- » Pipe loops laid horizontally are geothermal collectors.
- » Vertical probes are geothermal probes.

The heat pump is installed in rooms that are free from the risk of frost.

The heating heat pump is regulated by means of the heat pump manager. The heat pump manager can be installed inside the building, e.g. in a utility room. Some heat pumps have an integral heat pump manager.

Several appliances can be linked together to cover even higher heat loads with standard heating heat pumps. This is achieved with the aid of heat pump sets comprising two heat pumps and appropriate accessories.

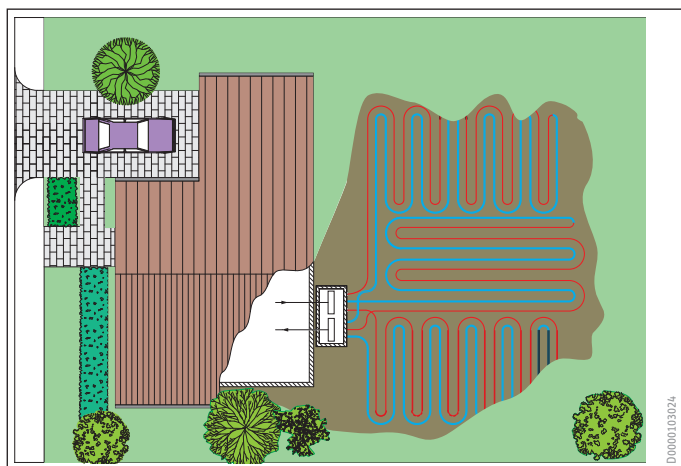

The ground heat source in central Europe is the topmost layer of soil down to a depth of approx. 2 m.

Heat is yielded via a heat exchanger that is buried horizontally in an area where no buildings are located, near the building to be heated.

The heat relevant to the extraction from the ground is stored solar energy that is transferred to the ground through direct irradiation, air-borne heat transfers and precipitation. This is also the energy source for the rapid regeneration of the supercooled ground at the end of the heating season.

Heat flowing up from deeper layers is just 0.05 to 0.12 W/m². It can be disregarded as a heat source for the upper soil layers.

The available heat and therefore the size of the required area is largely dependent on the thermo-physical properties of the ground and the irradiation energy, that is the climatic conditions.

The thermal properties, such as the volumetric thermal capacity and thermal conductivity are largely dependent on the consistency and condition of the ground. The control variables that are of particular relevance are the proportion of water, the proportion of mineral constituents, such as quartz and feldspar as well as the proportion and size of pores filled with air.

To put it simply, the storage characteristics and thermal conductivity are higher the more the ground is enriched with water, the

higher the proportion of mineral constituents and the lower the proportion of pores.

The extraction rate depends on the soil quality, the installation spacing and the depth.

Experience-based values for Germany

Geothermal collector		
Extraction rate	W/m ²	10 - 40
Spacing between pipes	m	0.6 - 1.0
Installation depth	m	1.2 - 1.5

To be able to utilise the ground as a heat source, plastic pipe loops (geothermal collectors) are buried underground. The heat transfer medium circulates through these pipes. The mixture transfers the heat extracted from the ground to the heat pump. The heat transfer medium must provide adequate frost protection. In addition, the medium must not damage the groundwater in case of a leak. This is a property of antifreeze with an ethylene glycol base. They have been developed especially for heat transfer and frost/corrosion protection in heat pump systems.

Extraction rate (VDI 4640)

Floor	qE [W/m ²]
Dry, non-binding soil	10 - 15
Moist, binding soil	15 - 20
Very moist, binding soil	20 - 25
Water-saturated soil	25 - 30
Ground with groundwater seam	30 - 40

Surface area (ground)

A corresponding surface area results, subject to the heat load of the house and the consistency of the ground. The required area of ground is determined on the basis of the cooling capacity Q_K of the heat pump.

The cooling capacity of the heat pump is the differential between the heating output Q_{WP} and the power consumption P_{WP} .

$$Q_K = Q_{WP} - P_{WP}$$

Geothermal heat pumps

Geothermal collector

Example

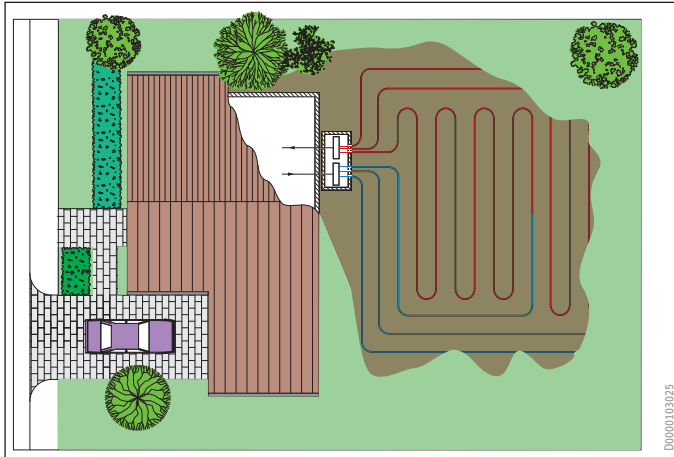

For sizing a geothermal probe, the heat pump's specifications are required.

Example heat pump data

Heating output at B0/W35 (EN 14511)	kW	10.31
Power consumption at B0/W35 (EN 14511)	kW	2.05
SCOP (EN 14825)		5.6
Nominal heating flow rate at B0/W35 and 7 K	m ³ /h	1.26
Sound power level W35 (EN 12102)	dB(A)	48
Sound power level W55 (EN 12102)	dB(A)	50
Ethylene glycol concentration, geothermal probe	Vol.-%	25
Ethylene glycol concentration, geothermal collector	Vol.-%	33

$$Q_K = 10.31 \text{ kW} - 2.05 \text{ kW}$$

$$Q_K = 8.26 \text{ kW}$$

Surface area (ground):

A specific extraction rate q_E of 25 W/m² results in the following area A:

$$A = \frac{Q_K}{q_E}$$

$$\text{Area A} = 8260 \text{ W} / 25 \text{ W/m}^2$$

$$\text{Area A} = 330.4 \text{ m}^2 \text{ ground}$$

Pipe spacing:

A pipe spacing of 0.6 m results in the following pipe length:

$$330.4 \text{ m}^2 / 0.6 \text{ m} = 551 \text{ metres of pipe, corresponding to six pipe circuits per 100 m length.}$$

Laying of pipes

The plastic pipes are buried at a depth of 1.2 to 1.5 m in several loops. For this, individual pipe loops should not exceed 100 m in length, otherwise larger circulation pumps with a higher power consumption would be required.

The spacing between pipes is subject to the soil condition and should be between 0.6 and 1.0 m. This prevents any ice radii from joining up and allows rainwater to soak away.

The pipes can be buried as part of the general groundwork when building a new house. In existing systems, excavators can be used.

Regulations

In Germany, geothermal collectors must be registered with and/or authorised by the relevant local water board.

Geothermal heat pumps

Geothermal collector

Installation

Geothermal collector made from PE pipes as heat source

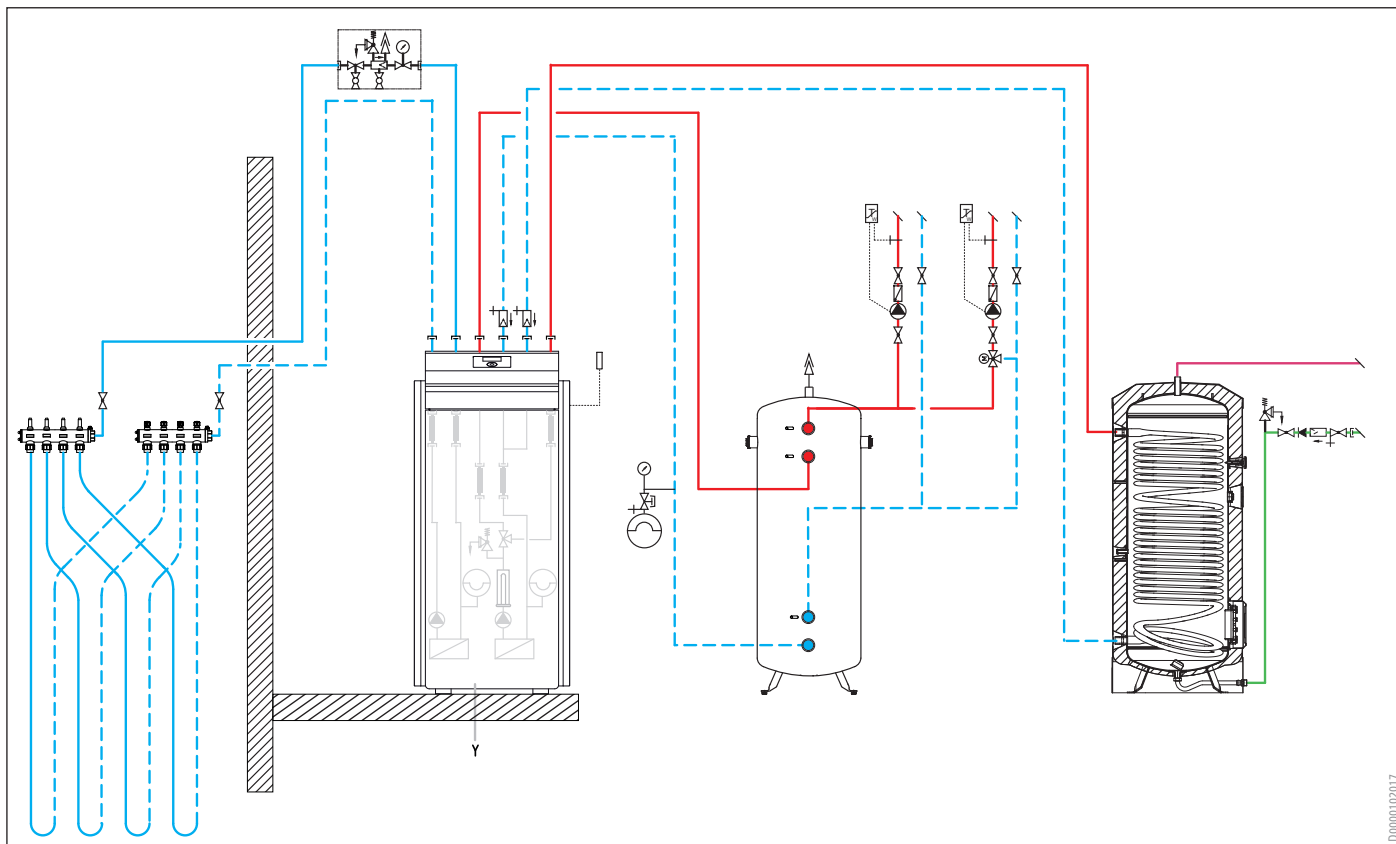

D10000102017

Geothermal heat pumps

Geothermal collector

Increase in heat source size

The extraction rates relative to area shown above refer to heat pump runtimes of 1800 to 2400 h per year. Runtimes apply to mono mode heat pump operation.

If the heat pump is used in dual mode parallel operation, the annual runtimes and the required geothermal collector size change.

As a result of the higher extraction rate, the geothermal collectors and collector surface area must be increased.

Calculation example for dual mode parallel operation

The heat pump is the base load heat generator and covers approx. 65 % of the heat load.

The maximum required heating flow temperature is 55 °C.

The system switches over to the second heat generator at an outside temperature of approx. -4 °C.

Factor f_Q for the increase in heat source size is determined using the diagram.

The factor for increasing the heat source size is 1.4.

Increasing the size of the heat source

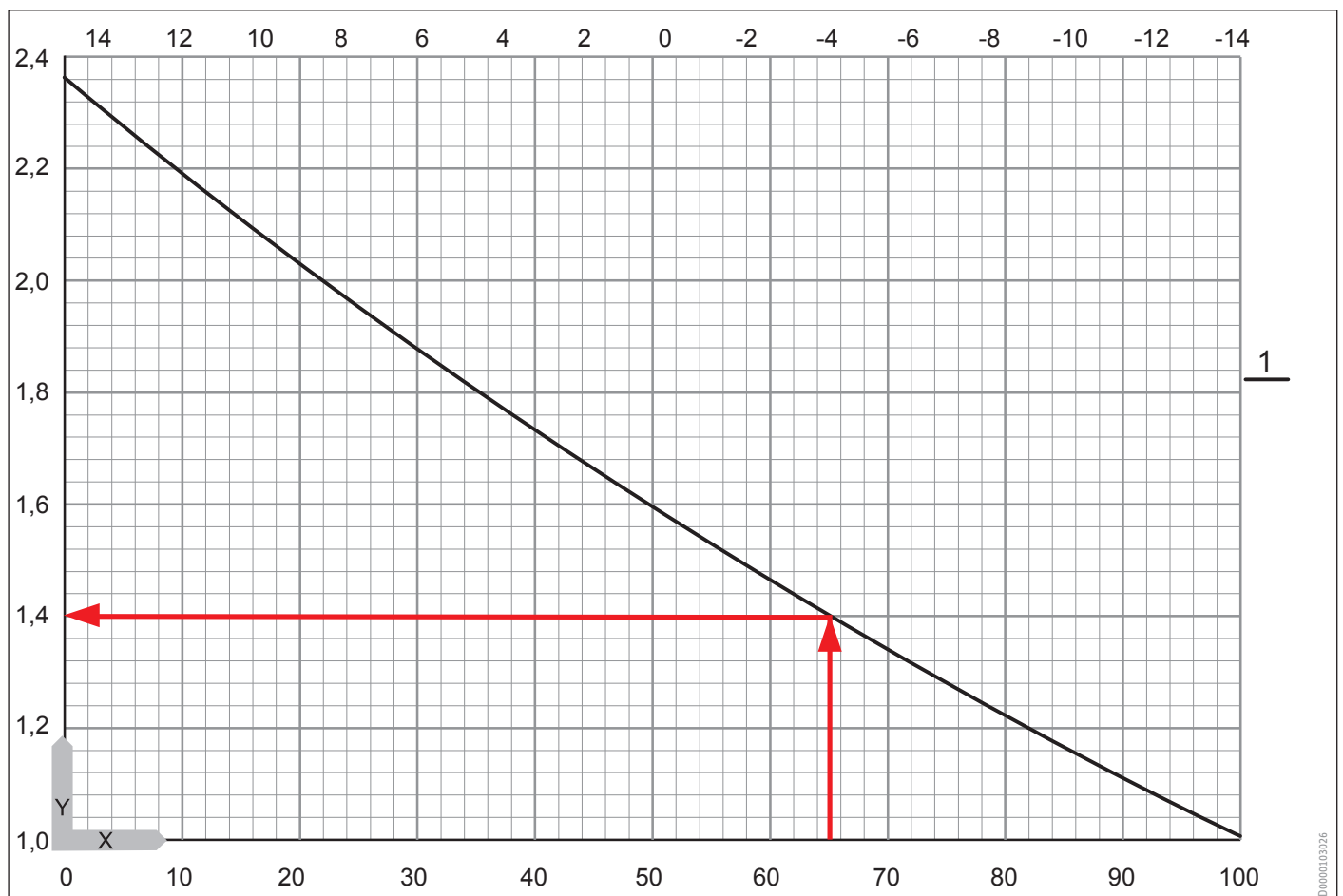

X Heating output / heat load [%] / dual mode point [°C]

Y Increase in heat source size * f_Q [-]

1 Curve, increase in heat source size

Geothermal heat pumps

Geothermal collector checklist

Ground source heat pumps, geothermal collector

- » Has a check been carried out to ascertain whether the heat pump installation site requires authorisation?
- » Has a check been carried out to ascertain whether the geothermal collector to be engineered requires authorisation?
- » Has the composition of the substrate been known to have been checked?
- » Has the possible extraction rate of the substrate been checked?
- » Has the operating mode of the heat pump been determined and is this suitable?
- » Is the size of the heat source system appropriate for the operating mode of the heat pump?
- » Has the output of the geothermal collector been taken into consideration?
- » Have the geothermal collector pipes been spaced so that ice radii cannot merge?
- » Has hydraulic engineering of the geothermal collector been completed?
- » Is the selected brine permissible for operation of the geothermal collector?
- » Has a technically feasible installation depth been selected for the geothermal collector?
- » Has all groundwork been matched to the pipe material and local conditions?

Heat generation

- » Have the results of the heat load calculation been taken into consideration?
- » Have the results of the cooling load calculation been taken into consideration?
- » Has a check been carried out to ascertain whether the installation of the heat pump system requires the prior authorisation of the local energy suppliers?
- » Is the availability of the necessary power supply guaranteed?
- » Have the requirements of the energy suppliers been met?
- » Have the maximum power consumption levels during heat pump start-up been taken into consideration?
- » Have the installation site requirements been met?
- » Have measures been taken to ensure that the selected heat pump will cover both the heating load and the cooling load?
- » Has the second heat generator been incorporated in accordance with the system design?
- » Have the DHW heating requirements been met?
- » Has the possibility of frost damage been ruled out?
- » Is there access for installation and maintenance work?
- » Have the necessary measures been taken to reduce noise emission?
- » Has the heat pump system been fitted with appropriate safety equipment?
- » Has any necessary equipment been provided for monitoring operating conditions?
- » Have the individual design stages been documented?
- » Has the heat distribution system been designed based on the heat load and heat pump output?
- » Has a check been carried out to ascertain whether it is necessary to split the entire heat distribution system among multiple distributor circuits?
- » Can the planned number of consumers be covered by the control unit?
- » Has any higher ranking control unit been taken into consideration in the design?
- » Have the individual heating circuits been designed based on the temperature level of the heat pump?
- » Have the individual cooling circuits been designed based on the temperature level of the heat pump?
- » Is dew point monitoring of the individual cooling circuits guaranteed?
- » Has any necessary buffer cylinder system been taken into consideration?

Notes

Geothermal heat pumps

Geothermal probe

General

Geothermal probes comprise a probe foot and endless, vertical probe pipes.

Pipe diameter		Depth
25 x 2.3	mm	60 m
32 x 3	mm	100 m

Specialist drilling contractors install these probes.

One 50 m long geothermal probe comprising 200 m PE pipe: 2 x 50 m flow line and 2 x 50 m return line.

This probe is inserted into a drilled hole in the ground. After inserting the pipes, the holes are filled under pressure with a suspension, e.g. bentonite. After curing, the suspension must provide a dense, permanent and physically stable connection between the geothermal probe and the surrounding rock. This ensures good thermal transfer.

Sizing

The system is sized in accordance with the flow of groundwater and the thermal conductivity of the ground.

In larger systems, several probes must be connected in parallel to extract the required cooling capacity from the ground.

Extraction rate of geothermal probes

Every geothermal probe has a specific extraction rate per metre of geothermal probe.

In the absence of information relating to ground conditions, an average specific extraction rate of 50 W/m can be used.

Extraction rate (VDI 4640)

Floor	W/m
Substrate with high groundwater flow	100
Solid rock with high thermal conductivity	80
Solid rock with normal substrate	55
Poor substrate, dry sediments	30



Note

The precise design is based on the ground conditions and water-carrying soil layers. Evaluation can only be carried out on site by the executing company.

Regulations in Germany

Geothermal probe systems up to a depth of maximum 100 m must be registered with and if necessary authorised by the relevant local water board.

At depths > 100 m, authorisation by the Higher Mining Office is required.

U-tube probe with base

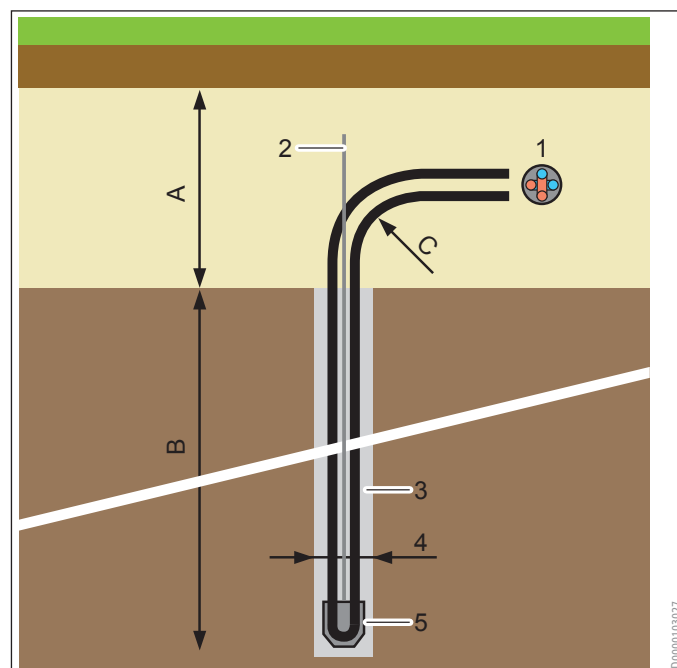

- A Bed of sand, min. 20 cm
- B Soil/drilling depth
- C Bending radius 40 cm
- 1 4-tube probe
- 2 Injection pipe
- 3 Cement-Opalite suspension
- 4 Hole diameter 110 - 133 mm
- 5 Probe base

Country comparison

In France, any depth of > 10 m requires a prior permit (Art. 131 of the "Code Minier"). At depths > 100 m, a permit is required (regulation 79-48 dated 28 March 1978).



Note

Observe the standards and regulations applicable in your country.

Geothermal heat pumps

Geothermal probe

Installation

Geothermal probe as heat source

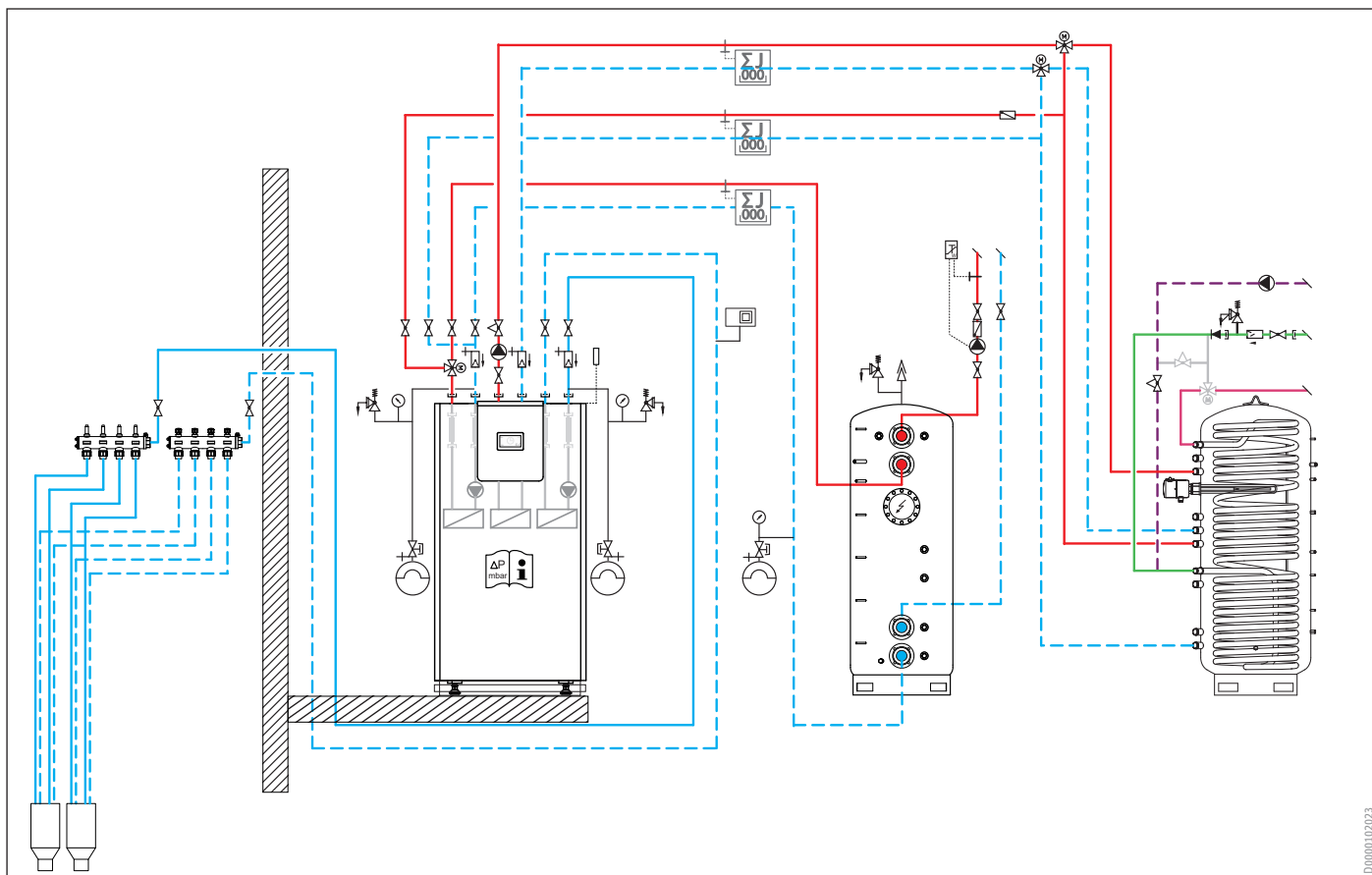

D10000102023

Geothermal heat pumps

Geothermal probe checklist

Ground source heat pumps, geothermal probe

- » If required, has a thermal reaction test been carried out?
- » Has authorisation been obtained from the relevant board?
- » Have the results of the heat load calculation been taken into consideration?
- » Have the results of the cooling load calculation been taken into consideration?
- » Has hydraulic engineering of the probe system been completed?
- » Has the operating mode of the heat pump been determined and is this suitable?
- » Is the size of the heat source system appropriate for the operating mode of the heat pump?

Heat generation

- » Have the results of the heat load calculation been taken into consideration?
- » Have the results of the cooling load calculation been taken into consideration?
- » Has a check been carried out to ascertain whether the installation of the heat pump system requires the prior authorisation of the local energy suppliers?
- » Is the availability of the necessary power supply guaranteed?
- » Have the requirements of the energy suppliers been met?
- » Have the maximum power consumption levels during heat pump start-up been taken into consideration?
- » Have the installation site requirements been met?
- » Have measures been taken to ensure that the selected heat pump will cover both the heating load and the cooling load?
- » Has the second heat generator been incorporated in accordance with the system design?
- » Have the DHW heating requirements been met?
- » Has the possibility of frost damage been ruled out?
- » Is there access for installation and maintenance work?
- » Have the necessary measures been taken to reduce noise emission?
- » Has the heat pump system been fitted with appropriate safety equipment?
- » Has any necessary equipment been provided for monitoring operating conditions?
- » Have the individual design stages been documented?
- » Has the heat distribution system been designed based on the heat load and heat pump output?
- » Has a check been carried out to ascertain whether it is necessary to split the entire heat distribution system among multiple distributor circuits?
- » Can the planned number of consumers be covered by the control unit?
- » Has any higher ranking control unit been taken into consideration in the design?
- » Have the individual heating circuits been designed based on the temperature level of the heat pump?
- » Have the individual cooling circuits been designed based on the temperature level of the heat pump?
- » Is dew point monitoring of the individual cooling circuits guaranteed?
- » Has any necessary buffer cylinder system been taken into consideration?

Notes

Water as heat source

Heat source system

Heat source system

A supply well and a return well are required for utilising groundwater as a heat source.

The available water quality must be ascertained by means of a water analysis.

The required flow rate (water volume of the WQA) must meet the heat pump requirements.

A pump test lasting several days must ascertain whether the water volume required by the heat pump is available.

As the volume and quality of the water remain unchanged, the heat pump process will not interfere as regards the Water Household Act [Germany].

In Germany, the heat pump operator must apply to the relevant water board to use the water.

Well construction

The wells must be at least 15 m apart. The return well returns the extracted water volume to the groundwater. When constructing wells, it must be ensured that the cooled water that enters the return well will not re-enter the area of the supply well.

The depth of the well drilling depends on the groundwater level. Experience has shown that most wells for heat pumps require a depth of between 5 m and 15 m.

Pipework

Always route the pipelines with a fall towards the wells.

Water as heat source

Well installation

Well installation

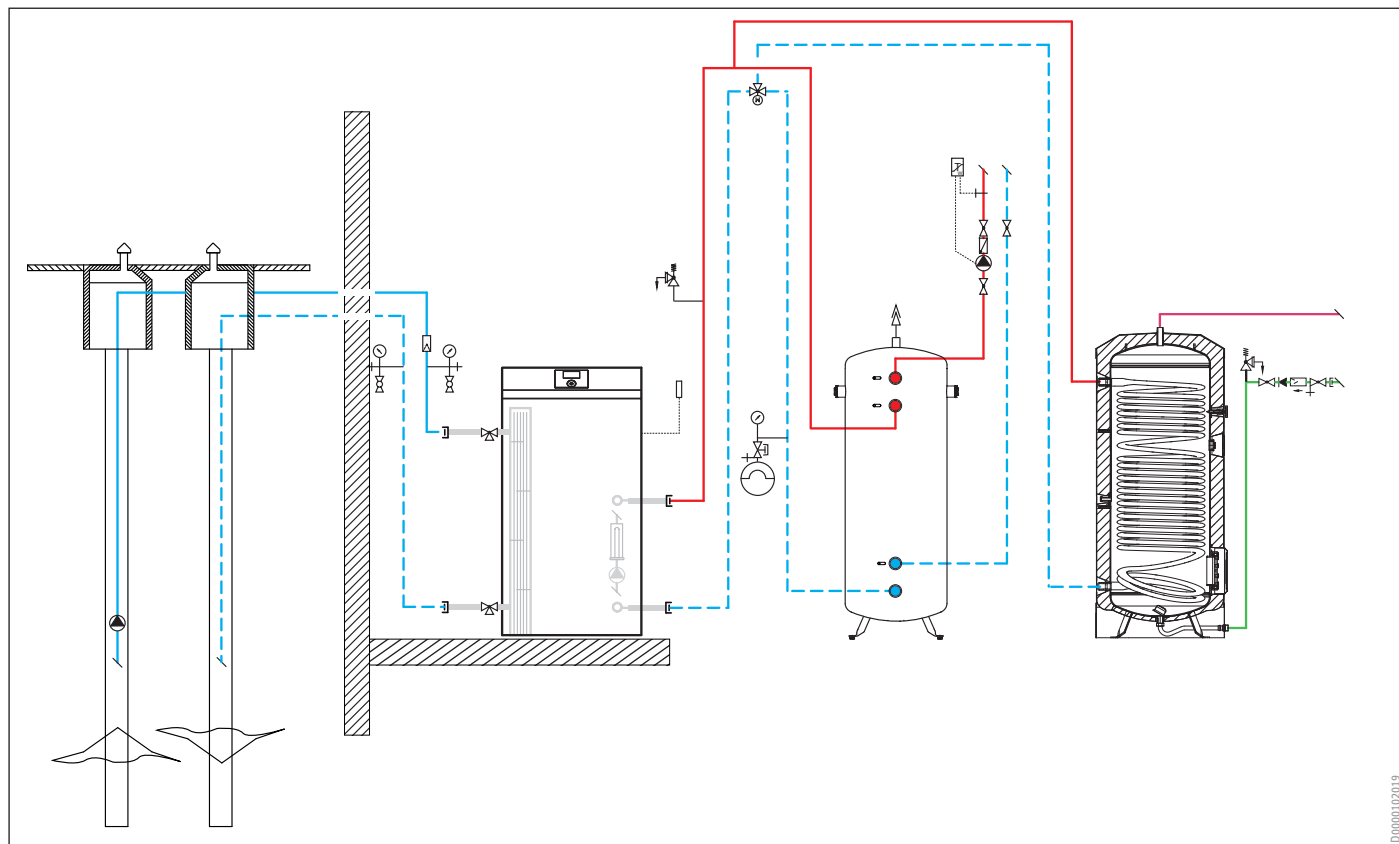

D0000102019

Water as heat source

Well pump

Well pump

Size the circulation pump of the heat source system in accordance with the system-specific conditions. The well pump must be sized based on the following details:

- » Heat pump flow rate on the heat source side
- » Heat pump pressure differential on the heat source side
- » Pressure differential in the line between the supply well and the return well
- » Experience shows that individual points of resistance, such as fittings and check valves, have pressure drops of up to 30 %, which must be added cumulatively to the pressure drops in the pipework.
- » Pressure drop in return well. Practical value: approx. 200 hPa
- » Geodetic head of the well system

The total of all pressure differentials and the heat pump flow rate enables the well pump to be determined from the manufacturer's diagram.

Water temperature

When used as a water source heat pump, the heating heat pump can be used down to the minimum heat source temperature. The minimum heat source temperature is product-specific.

Hydraulic connection

To prevent the transmission of noise as far as possible, connect the heat source circuit with flexible pressure hoses.

Proportion of solid particles in the well water

Solid particles suspended in the well water, such as sand and fine sludge, can result in the heat exchangers becoming blocked.

Allow for additional settlement basins and prefilters when the well water contains a high proportion of solid particles.

Well pump

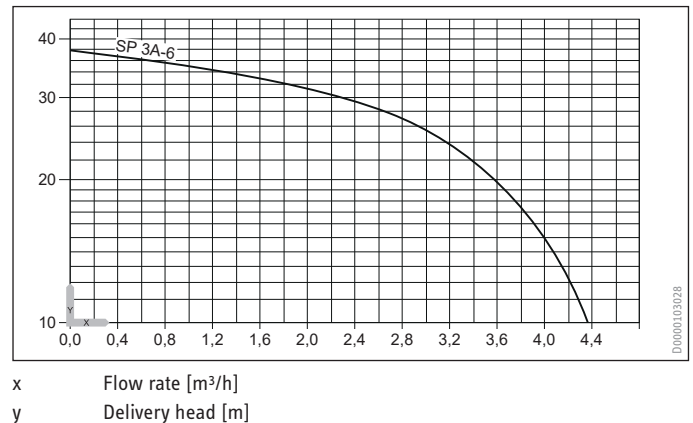

x Flow rate [m³/h]
y Delivery head [m]

Water as heat source

Intermediate heat exchanger

Intermediate circuit

If an intermediate circuit is to be used, ground source heat pumps can also be operated with groundwater as the heat source.

To separate well and heat source circuits, suitable plate heat exchangers for the relevant water quality must be used. The intermediate circuit must be filled with antifreeze and have safety valves and a circulation pump.

The heat source temperature for heat pumps with an intermediate heat exchanger is approx. 1-2 K lower than the groundwater temperature. When selecting the heat pump and the design point, the lower source temperature must be taken into consideration.

Required water quality

The following problems are typical when using groundwater:

- » Erosion of heat exchanger and water supply lines
- » Heat exchanger corrosion
- » Sludge contamination and/or blockages in heat exchanger and supply lines
- » Sedimentation (blocking) of the return well

To avoid these problems, the groundwater quality must meet the following requirements:

- » The water must not contain any matter that might settle.
- » Never use surface water.
- » Never use saline water.

Water as heat source

Checklist, water source heat pumps

Water source heat pumps, well system

- » Is the capacity of the well system for continuous supply and return of the flow rate required to cover the energy demand guaranteed?
- » Has a check been carried out to ascertain whether numerical thermal-hydraulic groundwater modelling needs to be carried out?
- » Are measures in place to ensure that the thermally altered groundwater is fully returned to the extraction groundwater reservoir?
- » Has any waterlogging of the site and damage to the building through well operation been ruled out?
- » Is reintroduction to the supply well carried out at a sufficient distance to rule out a thermal short circuit?
- » Is the groundwater chemically suitable for operation of a heat pump system?

Heat generation

- » Have the results of the heat load calculation been taken into consideration?
- » Have the results of the cooling load calculation been taken into consideration?
- » Has a check been carried out to ascertain whether the installation of the heat pump system requires the prior authorisation of the local energy suppliers?
- » Is the availability of the necessary power supply guaranteed?
- » Have the requirements of the energy suppliers been met?
- » Have the maximum power consumption levels during heat pump start-up been taken into consideration?
- » Have the installation site requirements been met?
- » Have measures been taken to ensure that the selected heat pump will cover both the heating load and the cooling load?
- » Has the second heat generator been incorporated in accordance with the system design?
- » Have the DHW heating requirements been met?
- » Has the possibility of frost damage been ruled out?
- » Is there access for installation and maintenance work?
- » Have the necessary measures been taken to reduce noise emission?
- » Has the heat pump system been fitted with appropriate safety equipment?
- » Has any necessary equipment been provided for monitoring operating conditions?
- » Have the individual design stages been documented?
- » Has the heat distribution system been designed based on the heat load and heat pump output?
- » Has a check been carried out to ascertain whether it is necessary to split the entire heat distribution system among multiple distributor circuits?
- » Can the planned number of consumers be covered by the control unit?
- » Has any higher ranking control unit been taken into consideration in the design?
- » Have the individual heating circuits been designed based on the temperature level of the heat pump?
- » Have the individual cooling circuits been designed based on the temperature level of the heat pump?
- » Is dew point monitoring of the individual cooling circuits guaranteed?
- » Has any necessary buffer cylinder system been taken into consideration?

Notes



www.stiebel-eltron.com

STIEBEL ELTRON GmbH & Co. KG | Dr.-Stiebel-Straße 33
37603 Holzminden | www.stiebel-eltron.de

STIEBEL ELTRON